

**ET423**



# FASCICOLO TECNICO

Versione 01



Pag. 6



Pag. 7

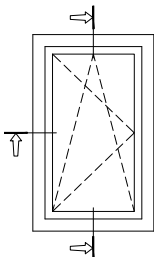

Pag. 5



Pag. 19



Pag. 19

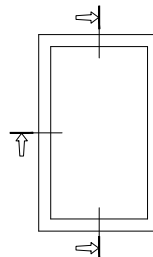

Pag. 18



Pag. 7



Pag. 6

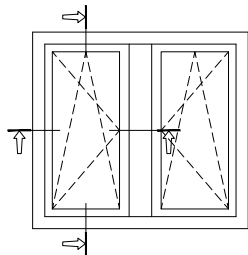

Pag. 8-9



Pag. 5



Pag. 7



Pag. 6

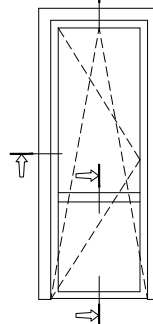

Pag. 12



Pag. 10-11



Pag. 7



Pag. 6

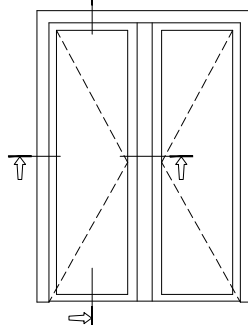

Pag. 14-15

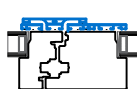

Pag. 16



Pag. 17



Pag. 19



Pag. 19



Pag. 22

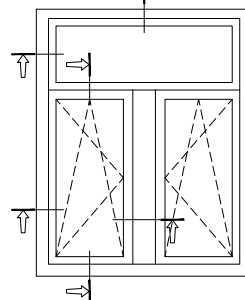
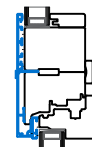

Pag. 6



Pag. 5

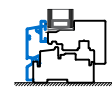

# Annotazioni varie

A series of horizontal dashed lines for taking notes.

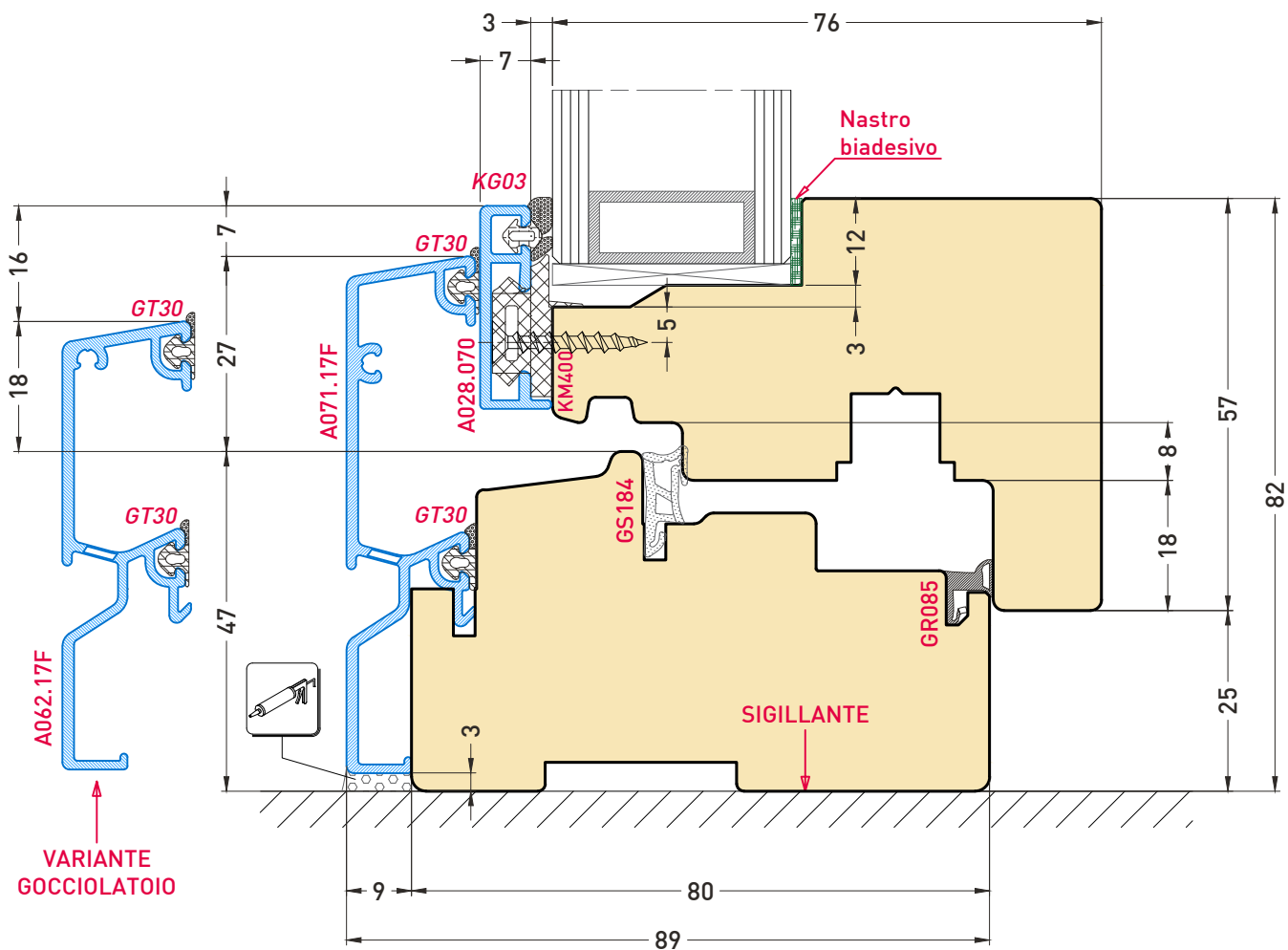
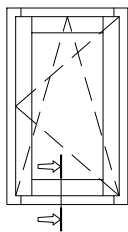

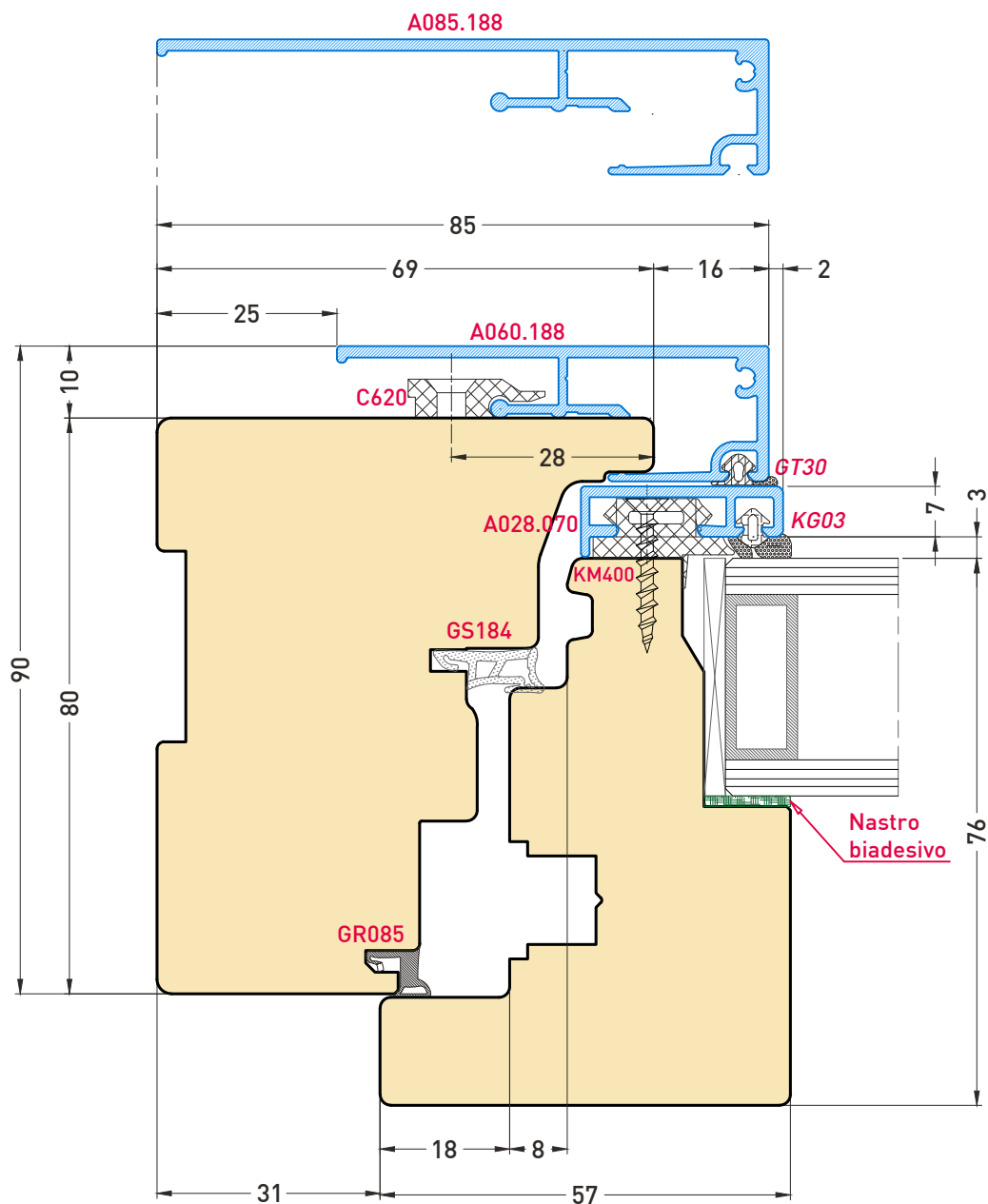
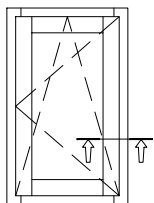

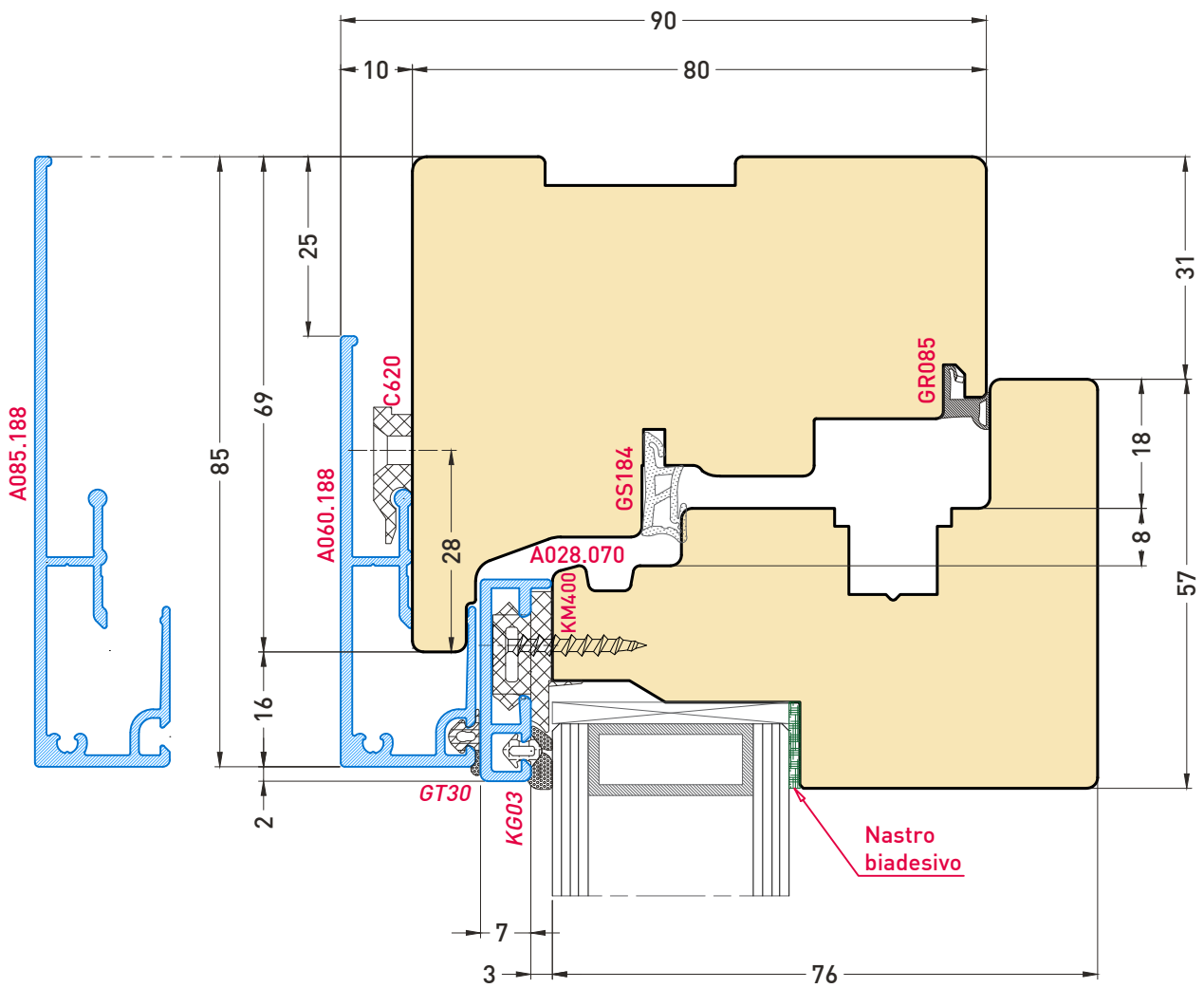

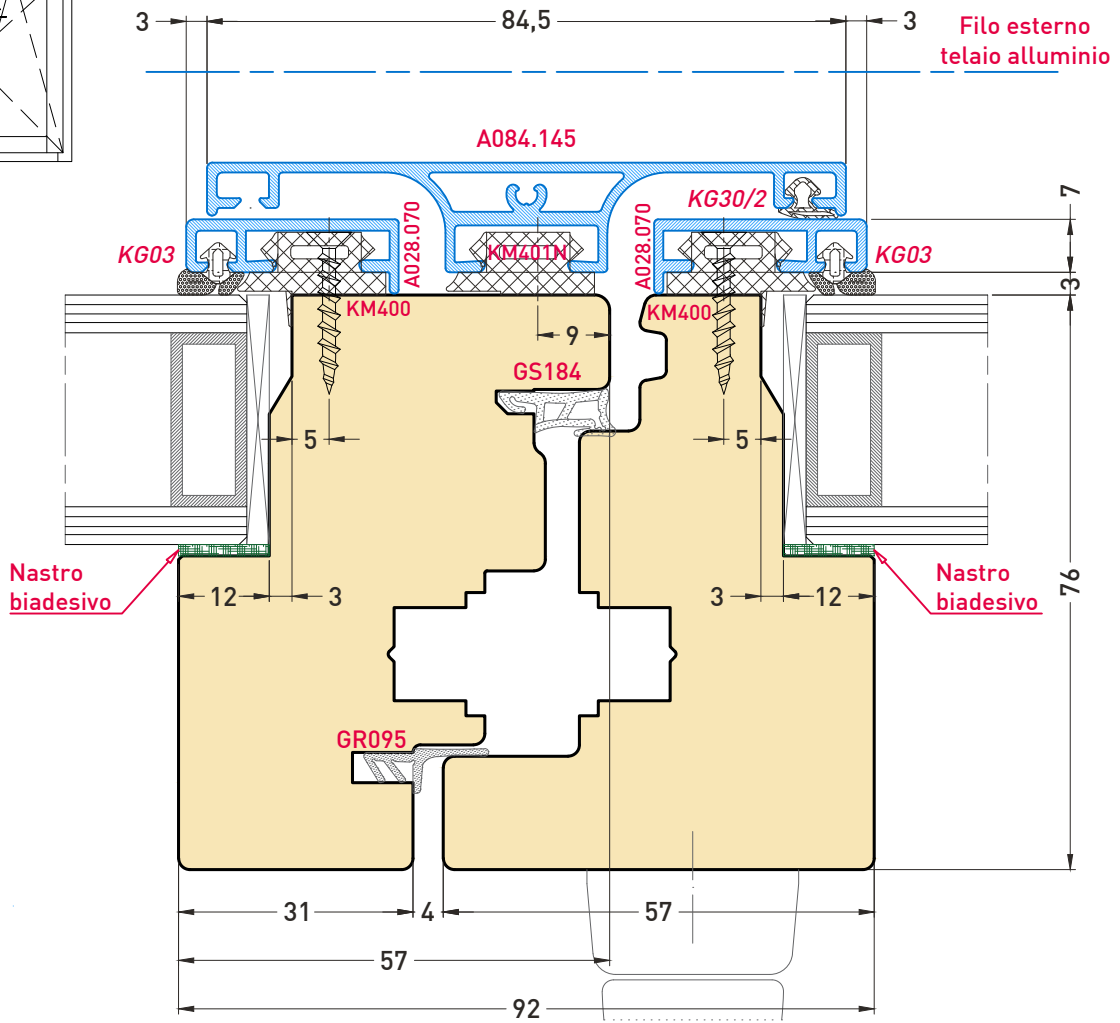
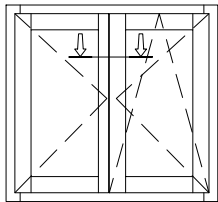

**Fissaggio terminali su FIN**

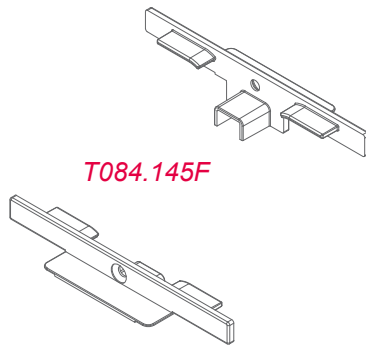
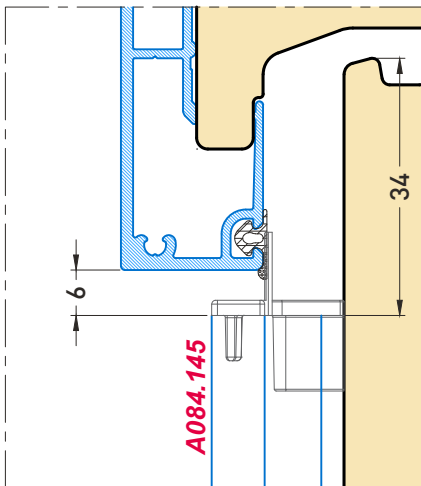

**Terminale inf. PORTAFIN**

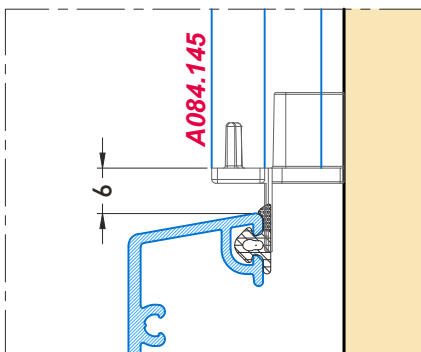
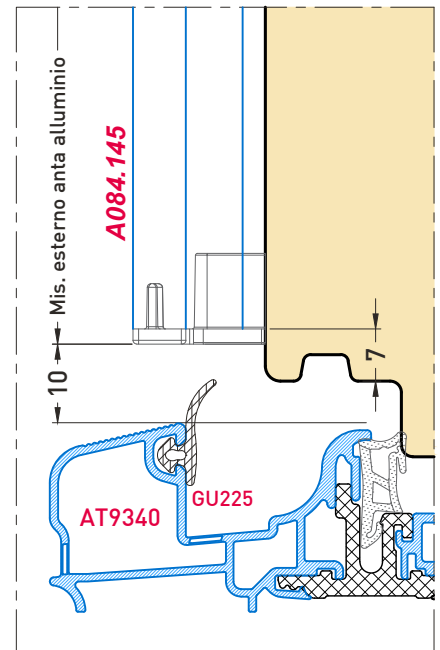

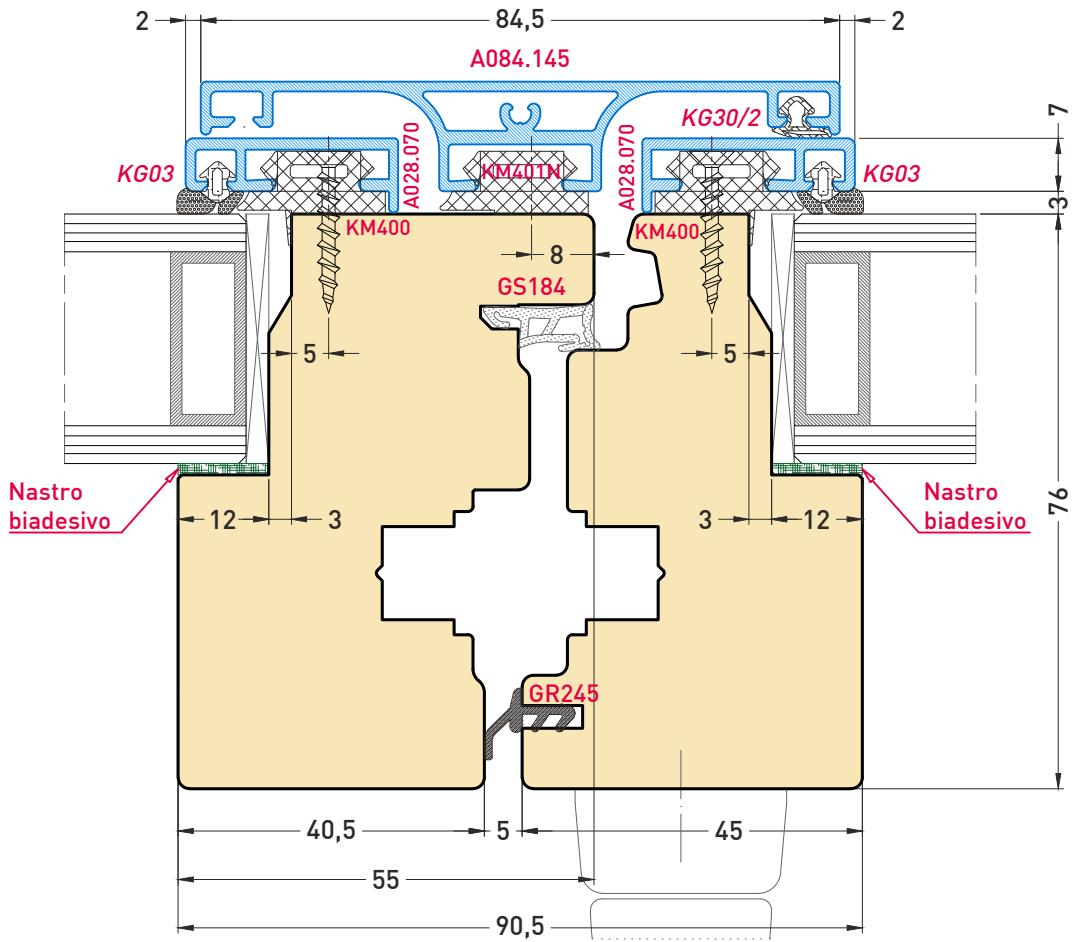

**VARIANTE - 1 -**

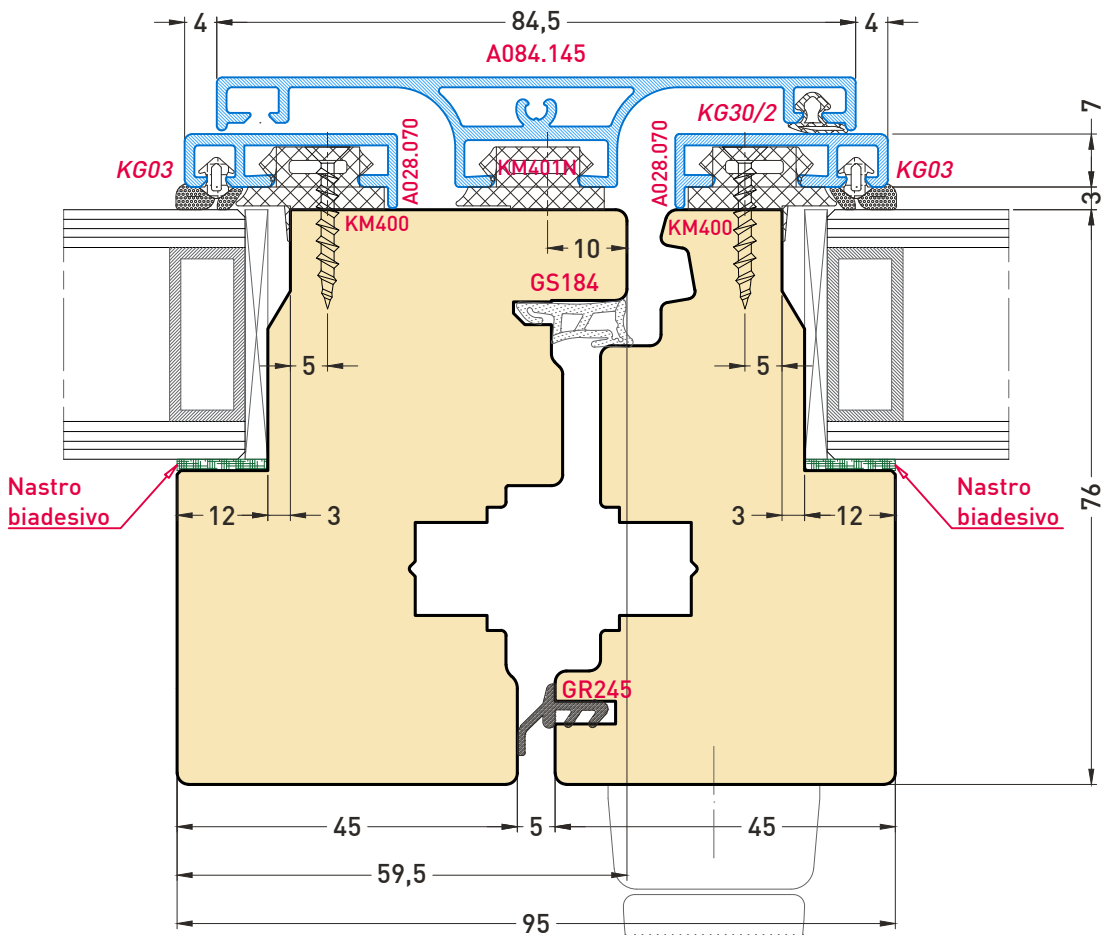

**VARIANTE - 2 -**

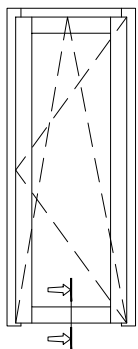

Intestatura montanti telaio

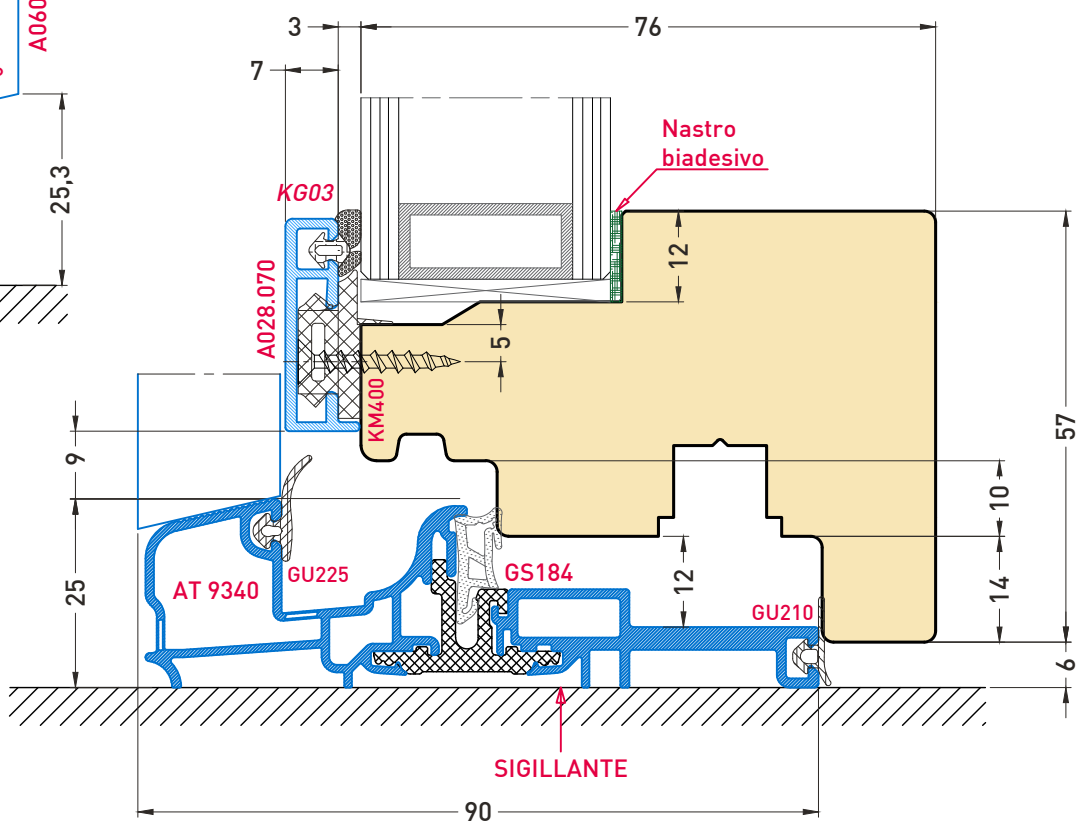
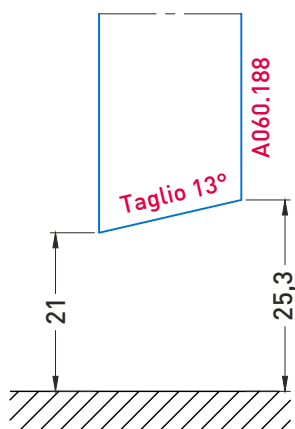

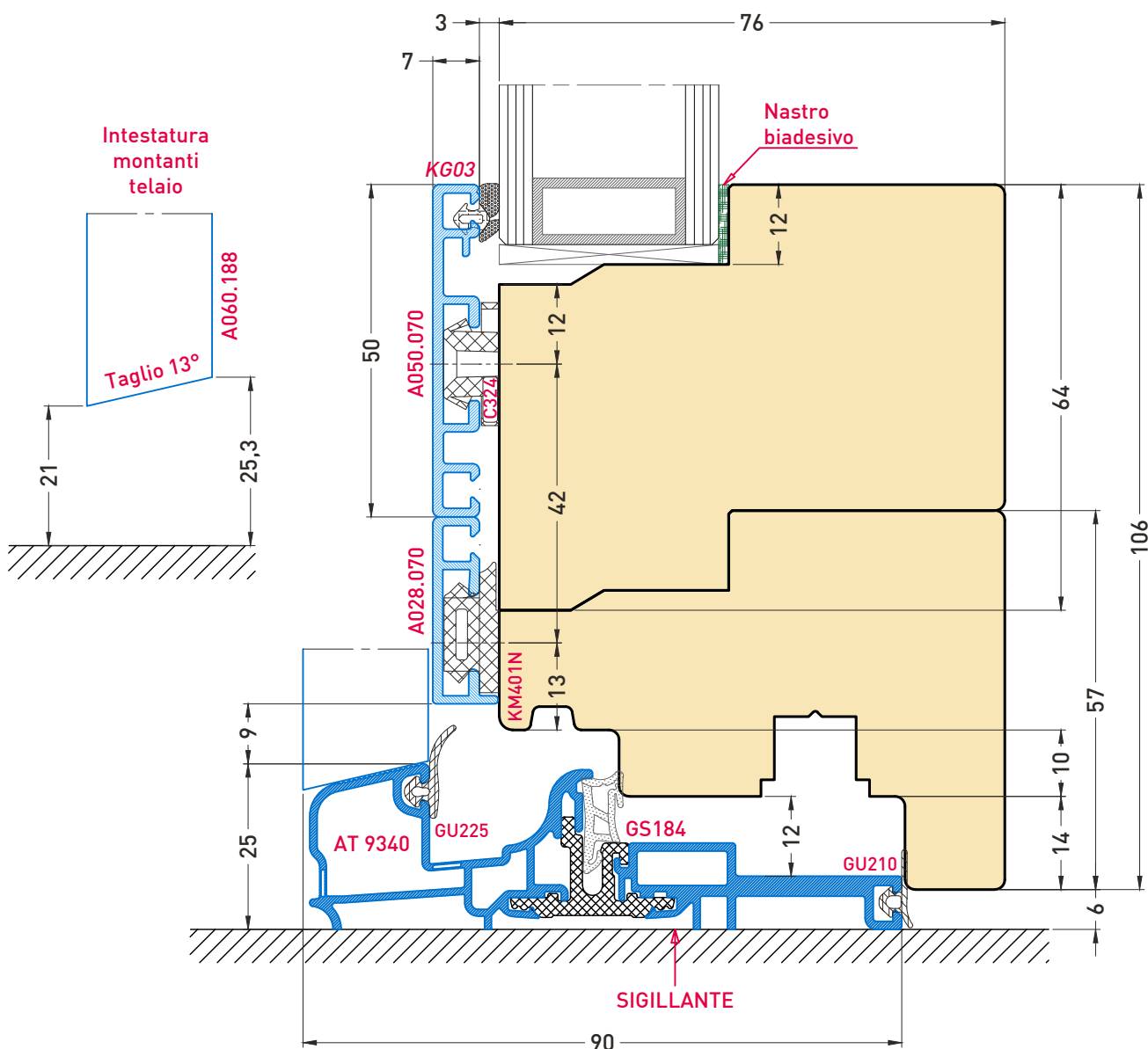
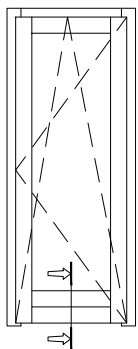

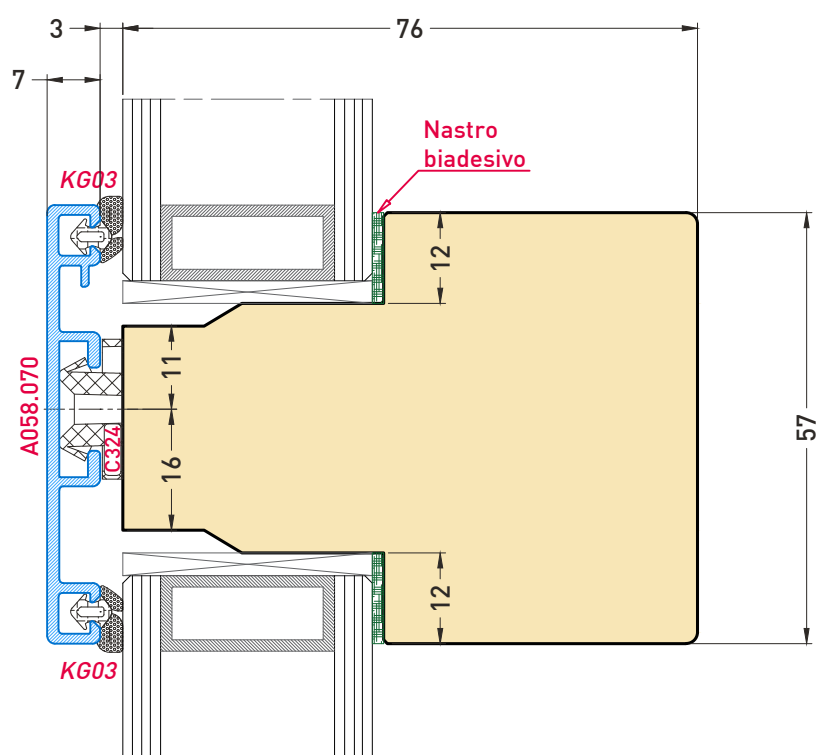
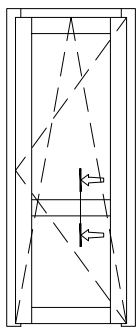

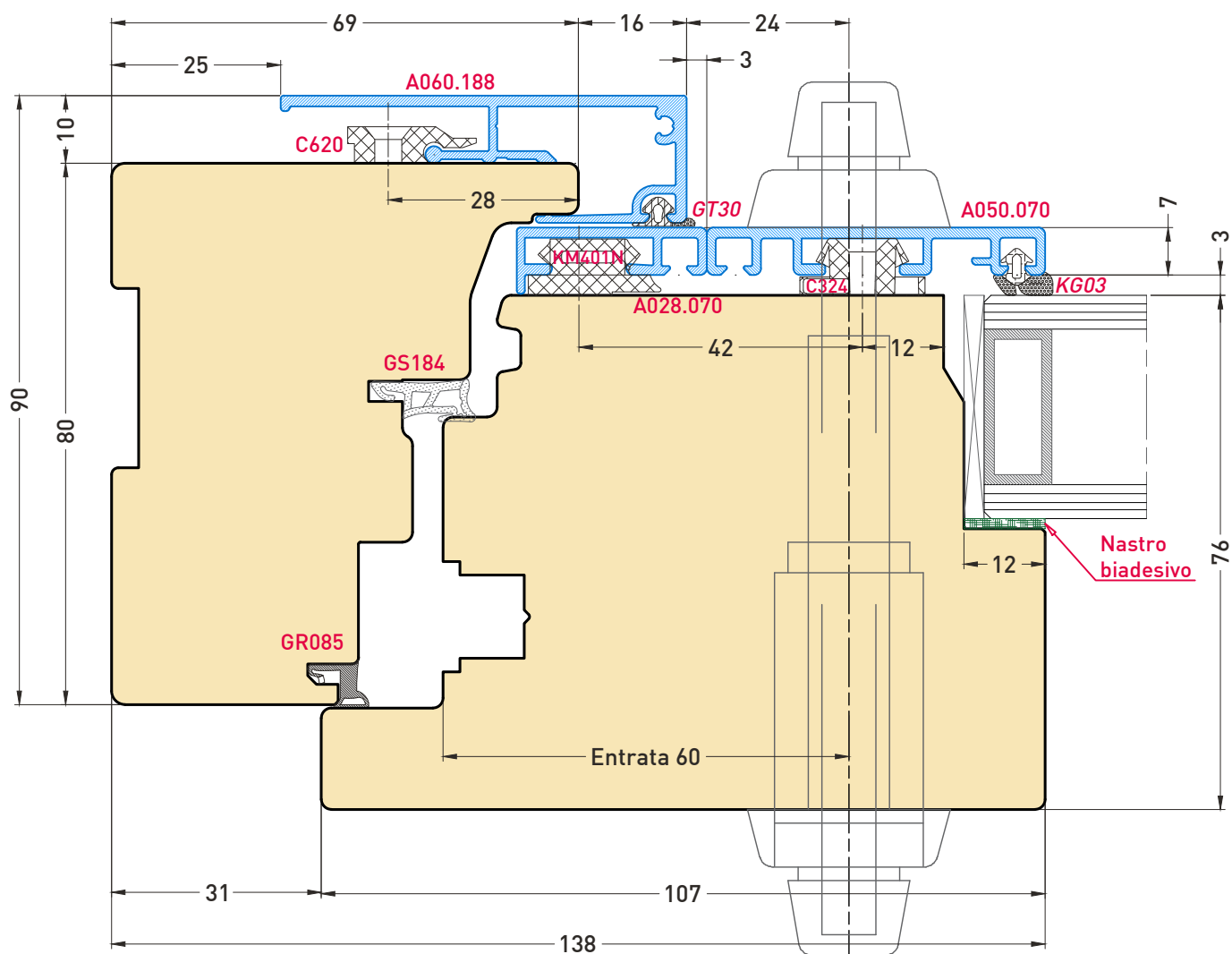
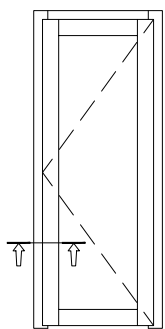

Sezione maggiorata SOLO  
su montante con serratura

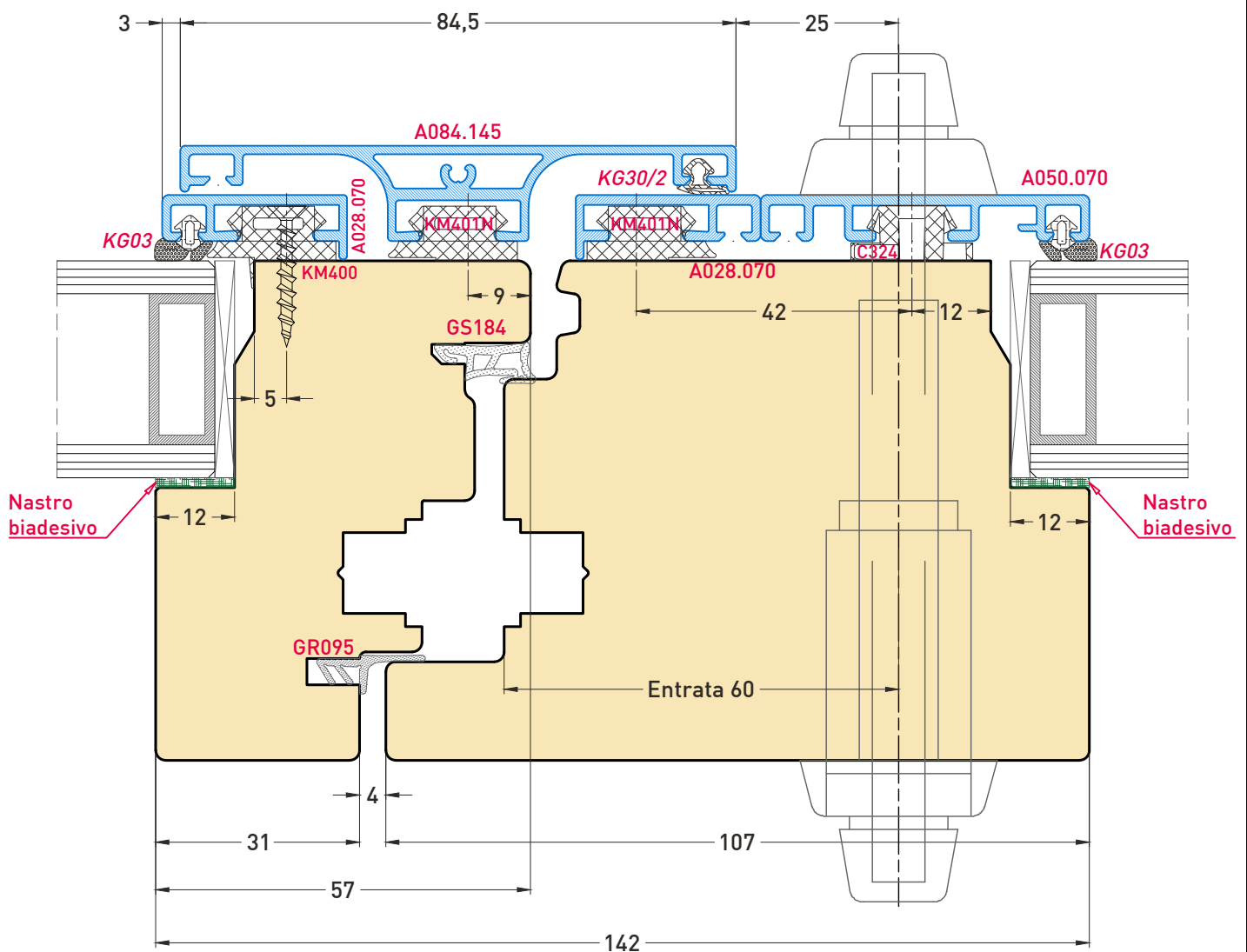
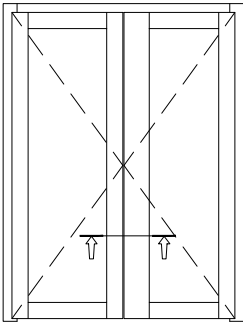

Sezione maggiorata SOLO  
su montante con serratura

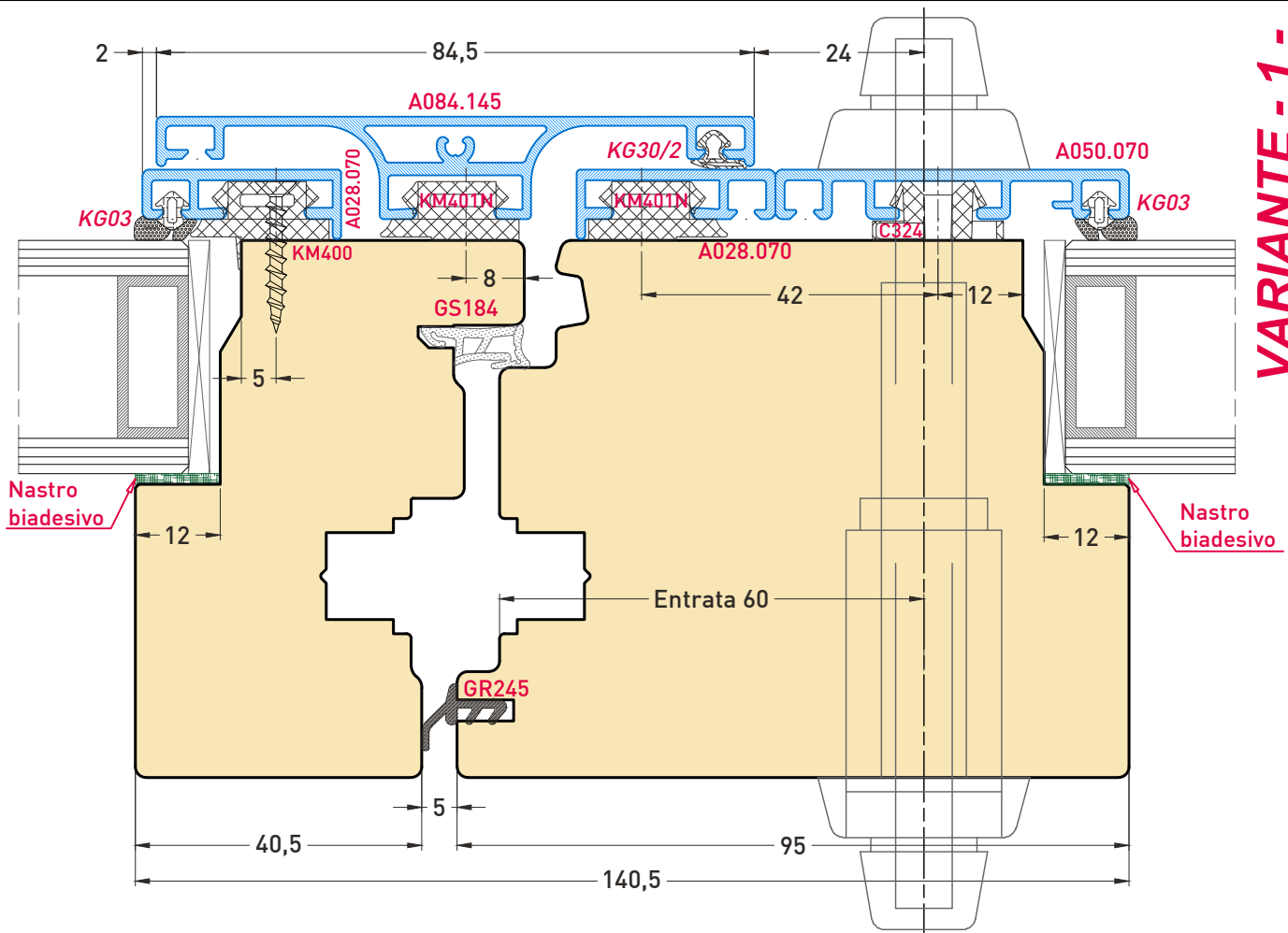

VARIANTE - 1 -

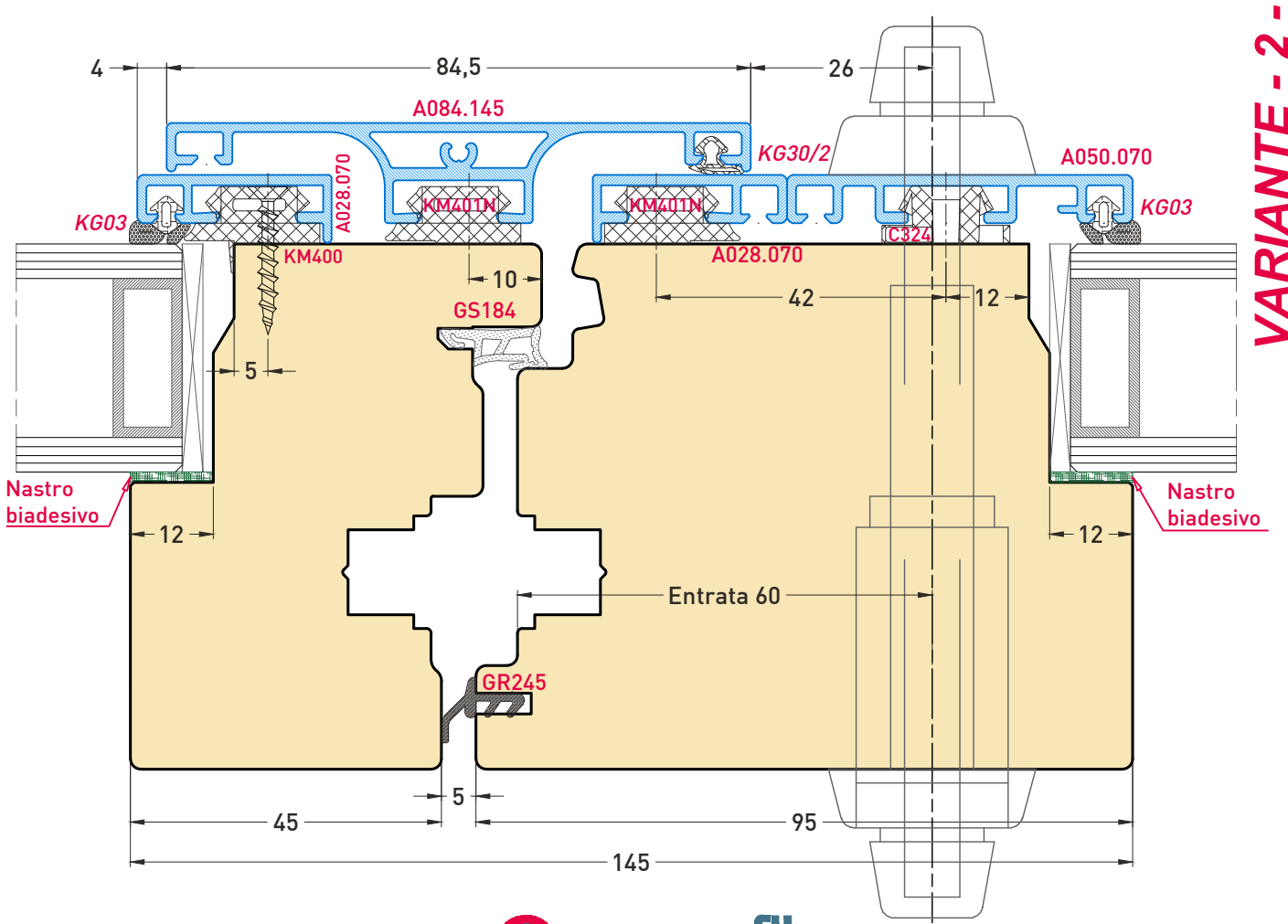

VARIANTE - 2 -

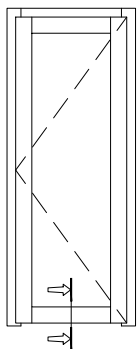

Intestatura  
montanti  
telaio

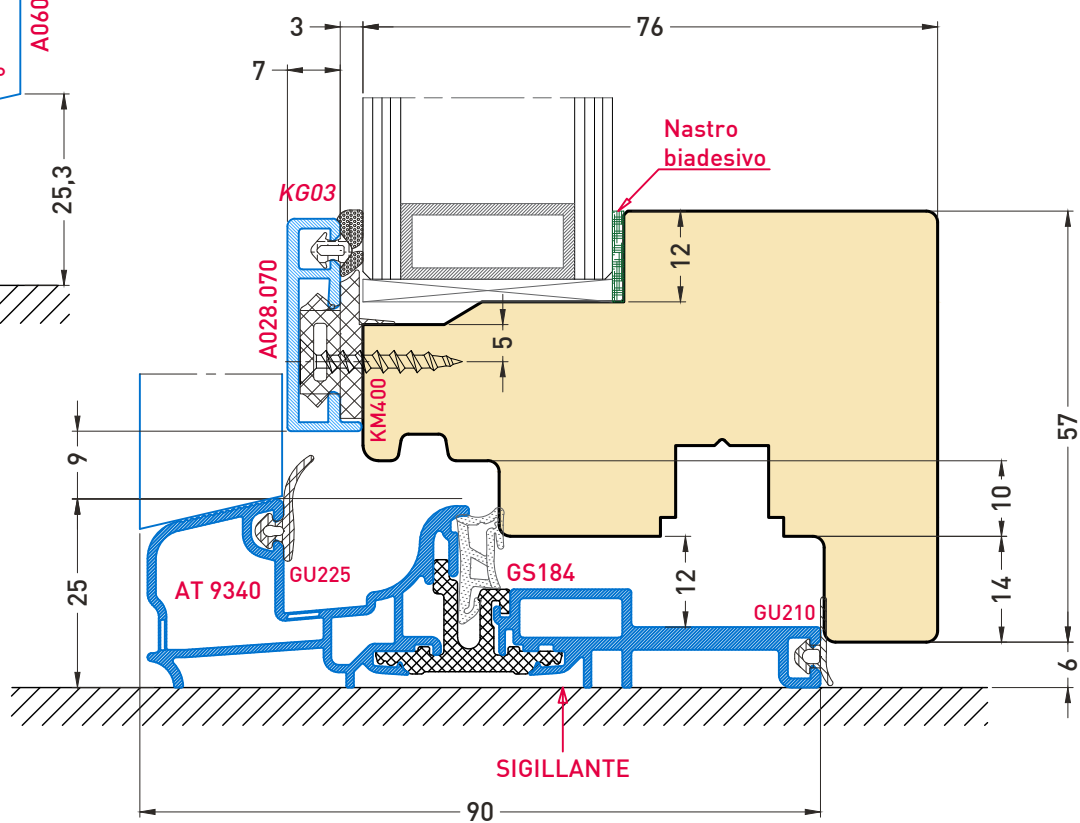
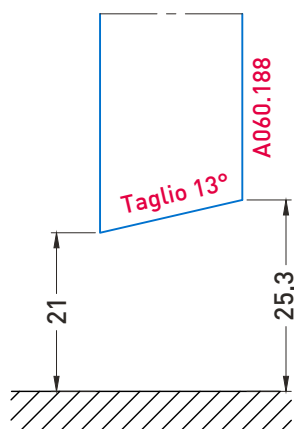

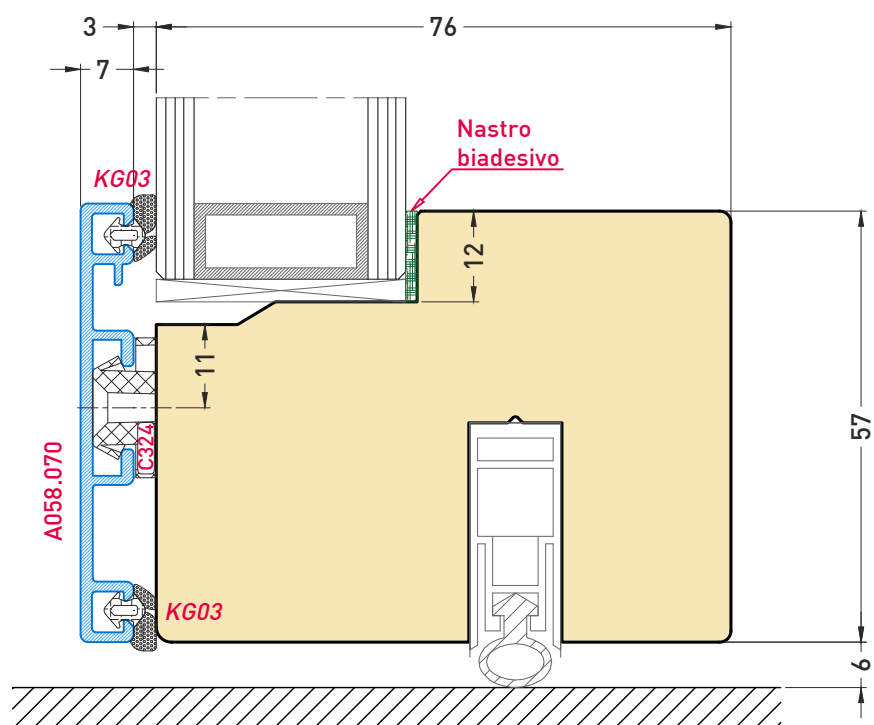
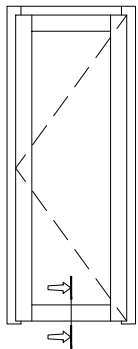

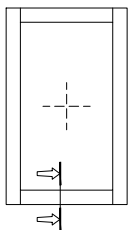

Clip per sicurezza vetro  
OPZIONALE  
Consigliata su vetri di  
grandi dimensioni

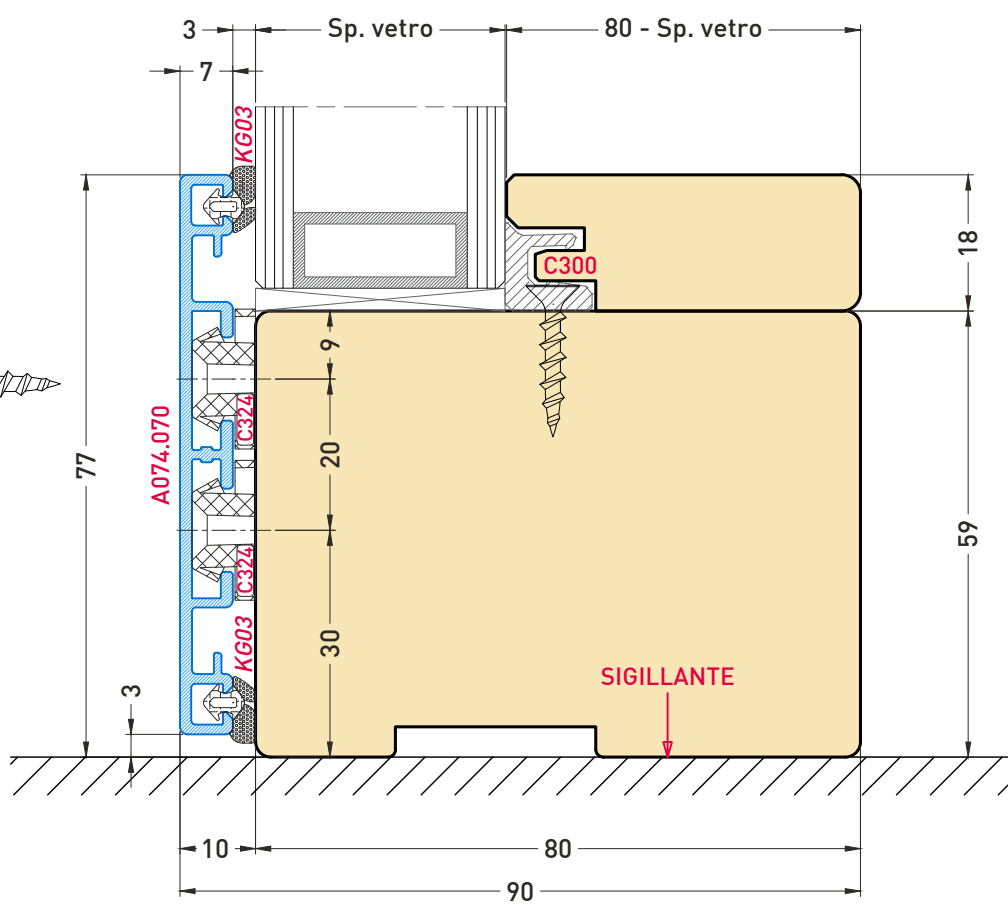
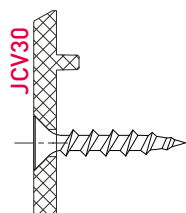

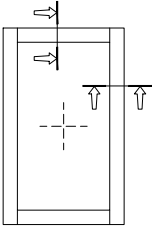

Clip per sicurezza vetro  
OPZIONALE  
Consigliata su vetri di  
grandi dimensioni

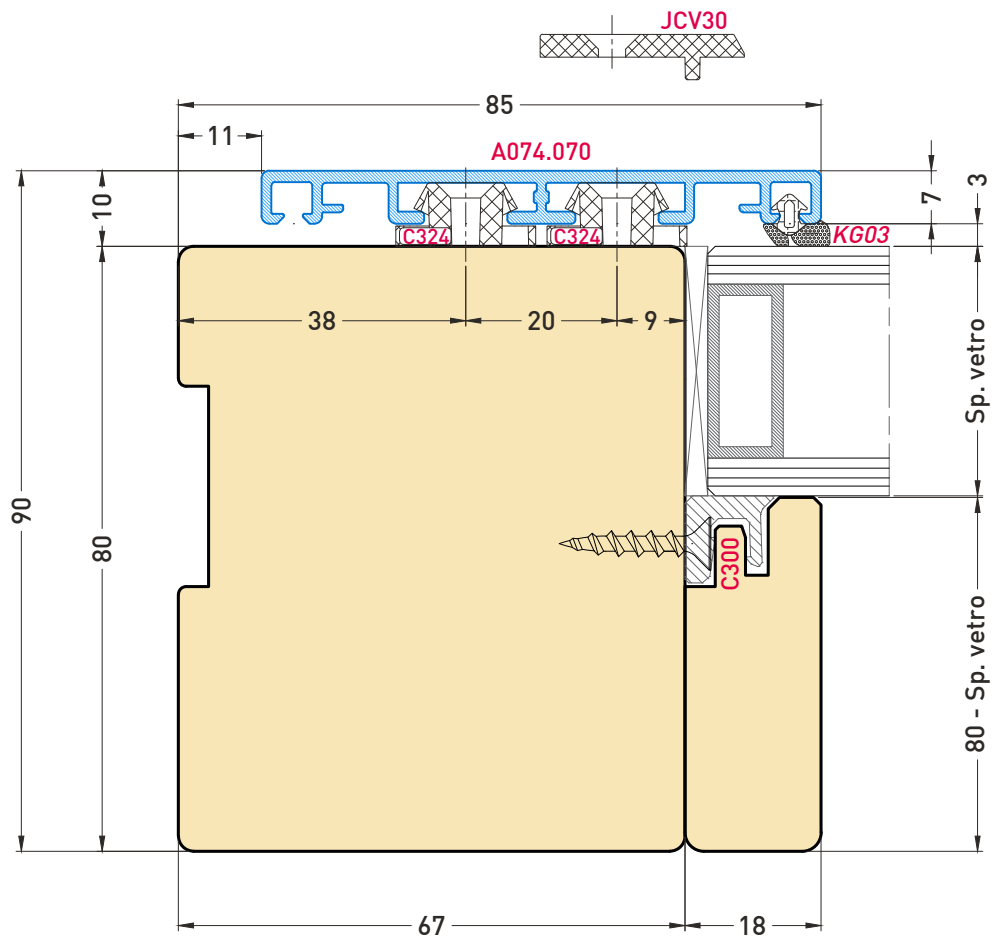

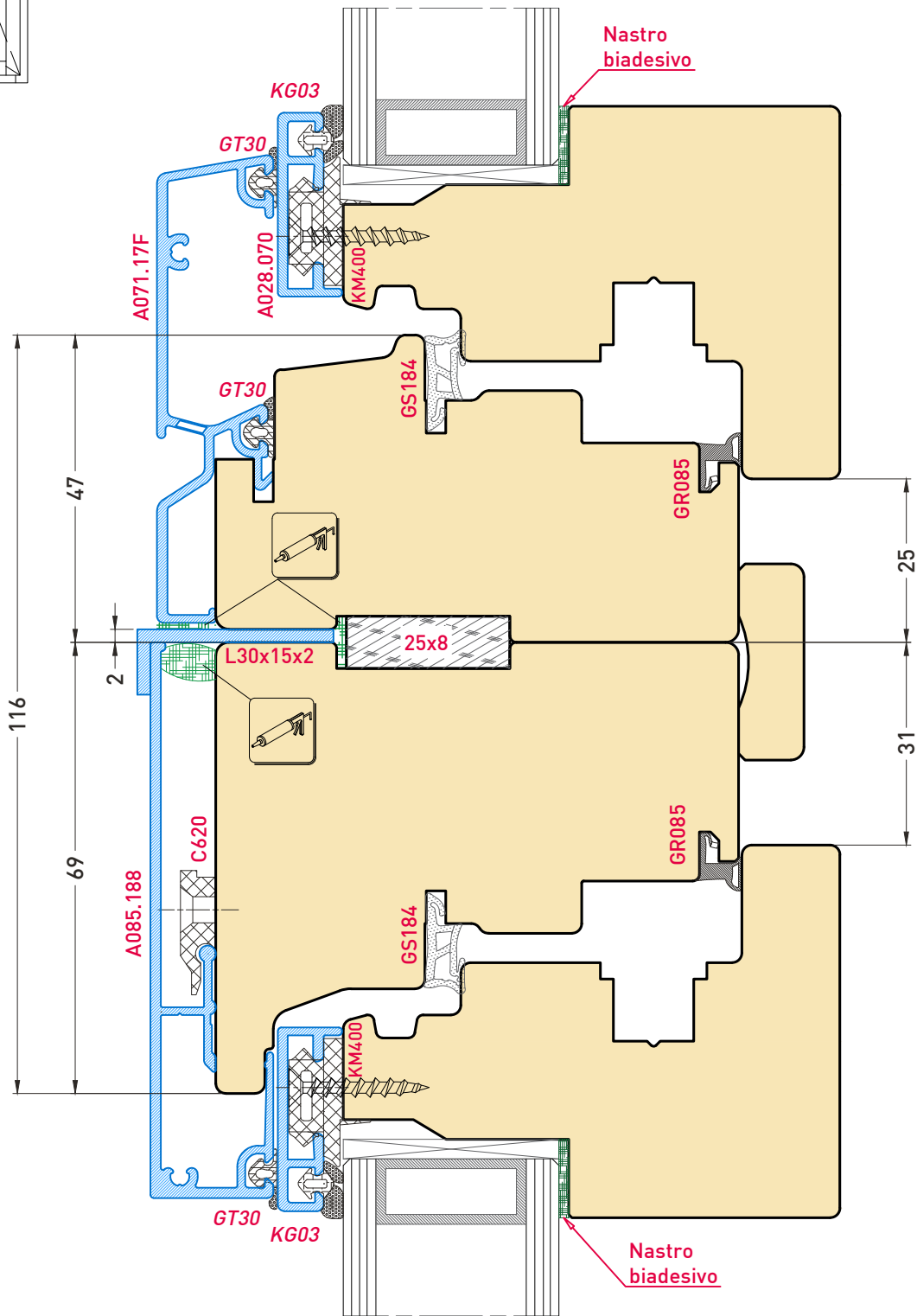
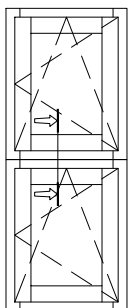

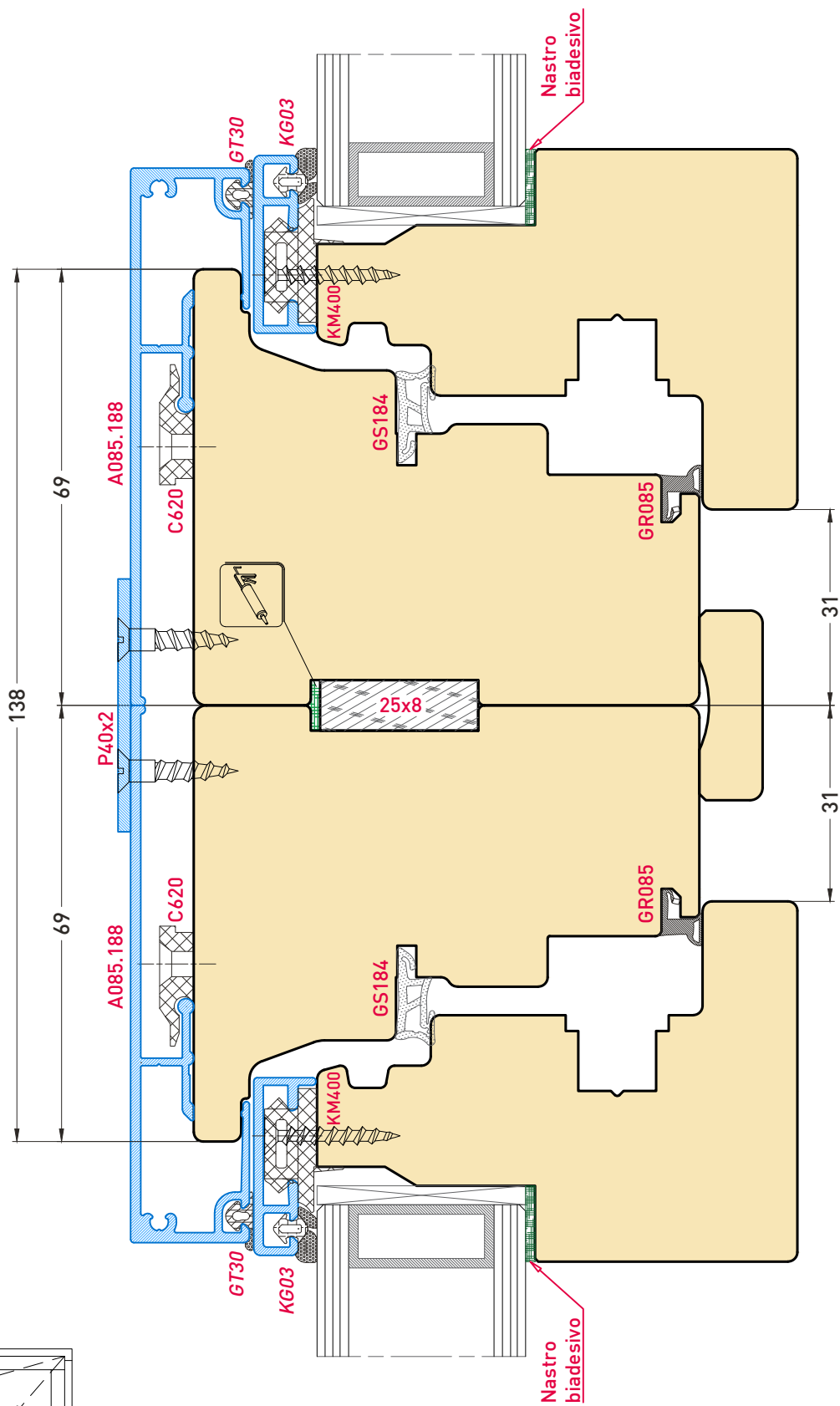
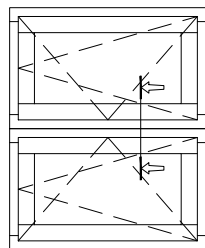

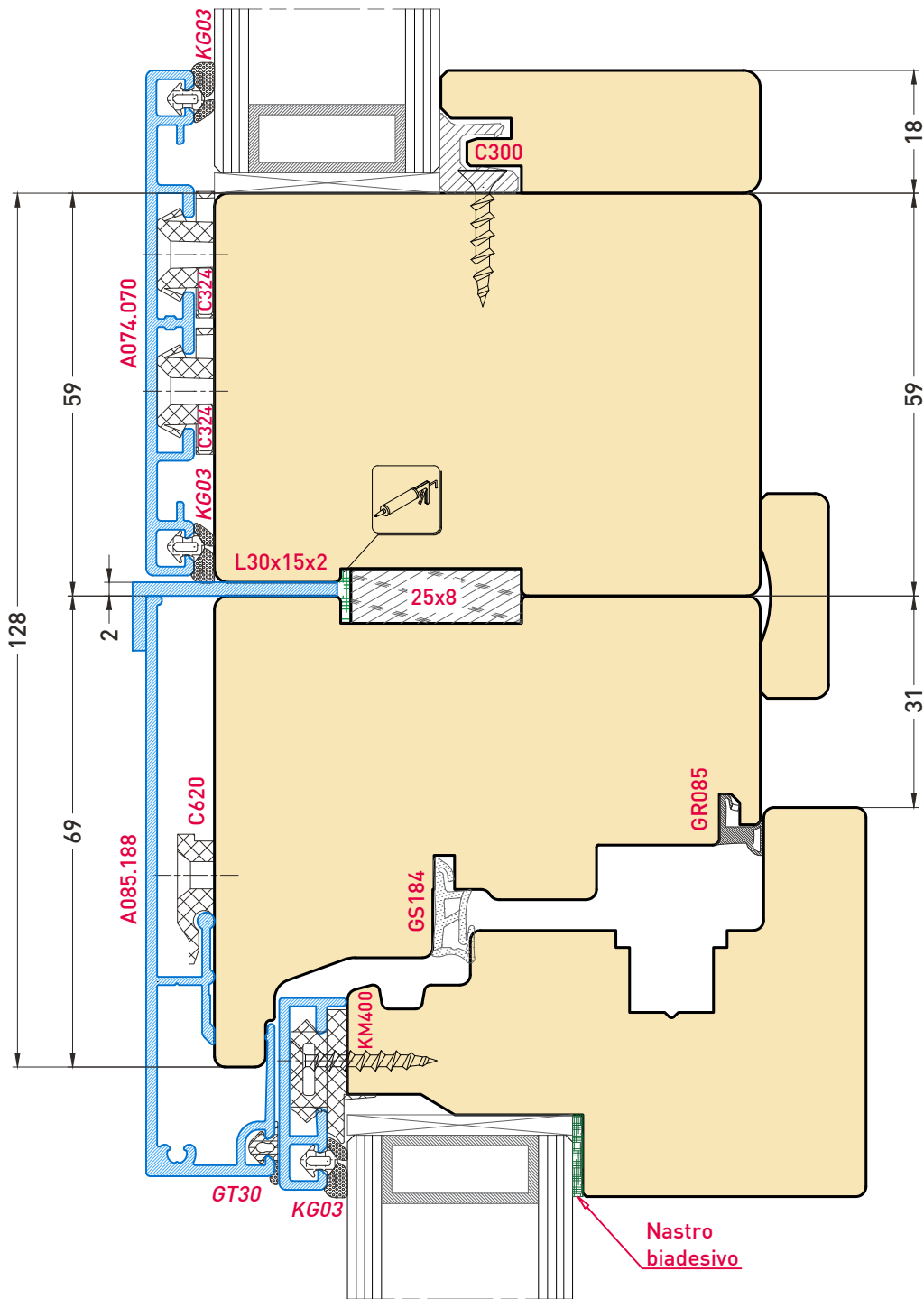
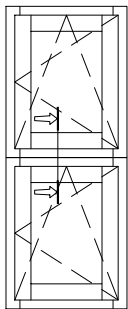

# Annotazioni varie

A series of horizontal dashed lines for taking notes.

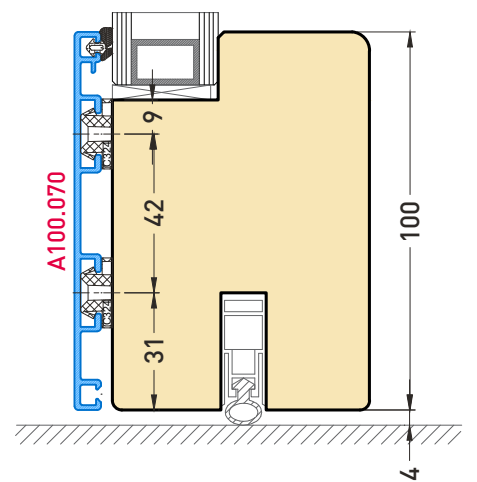
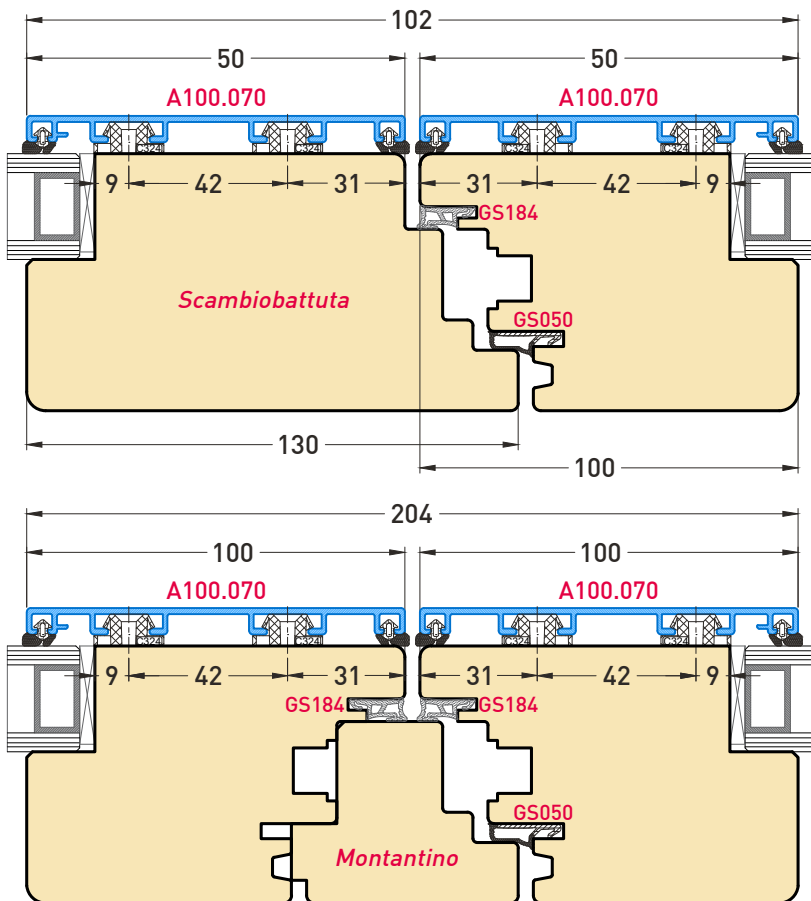
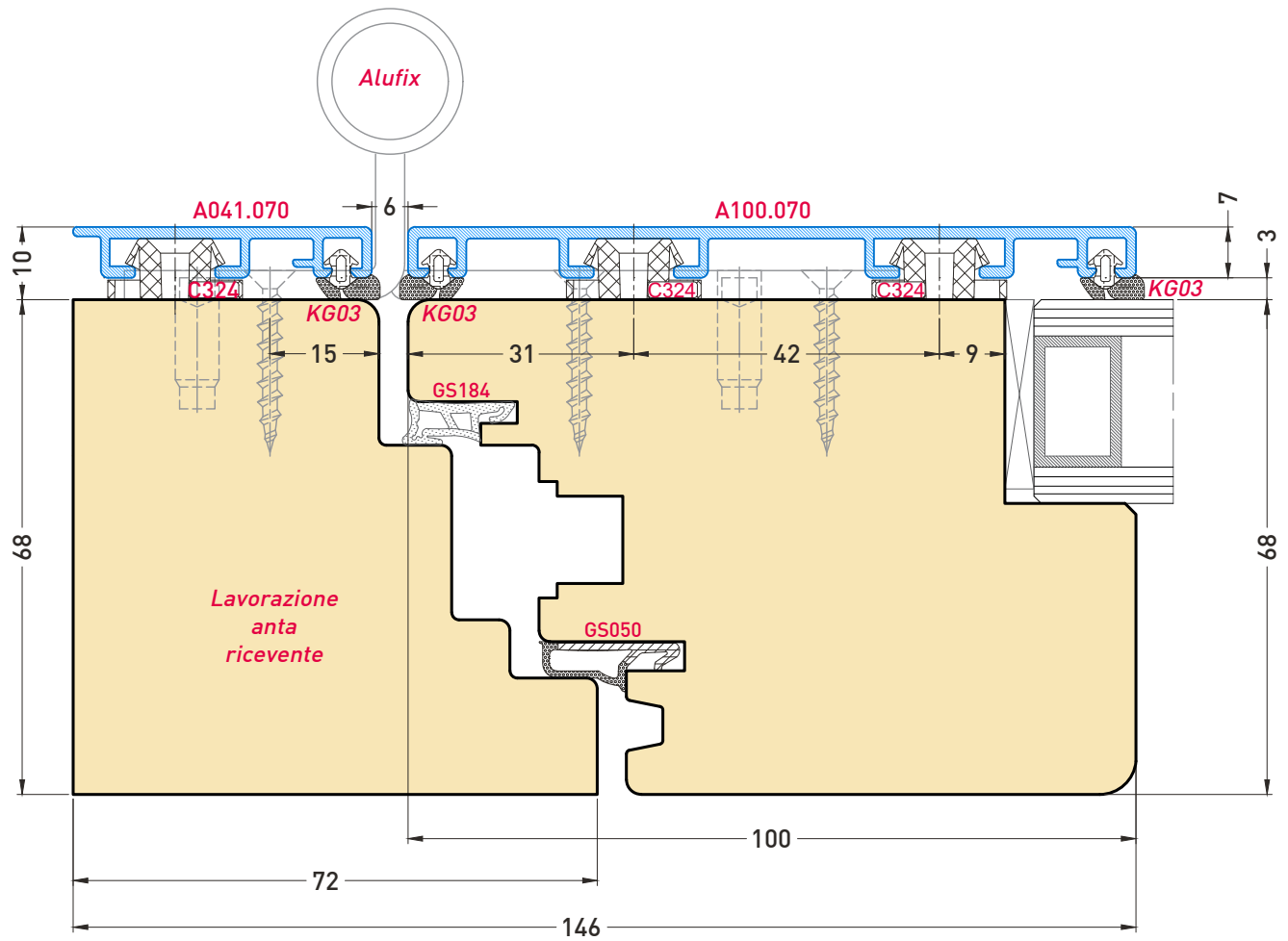

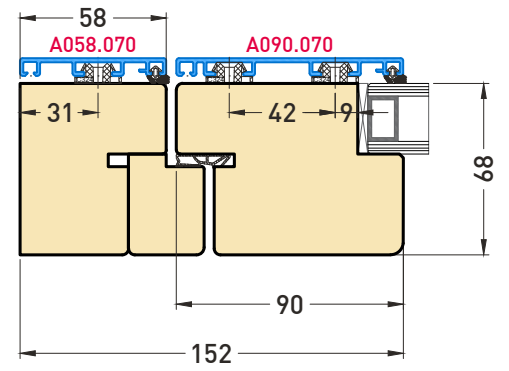
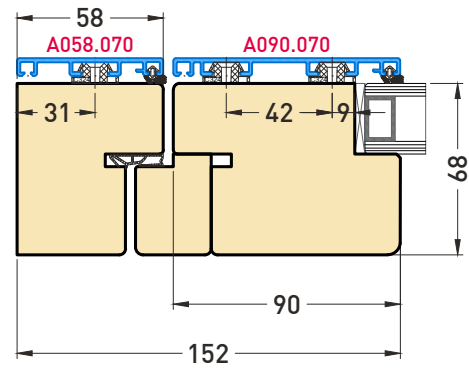
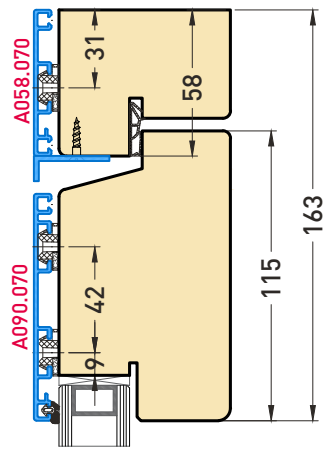
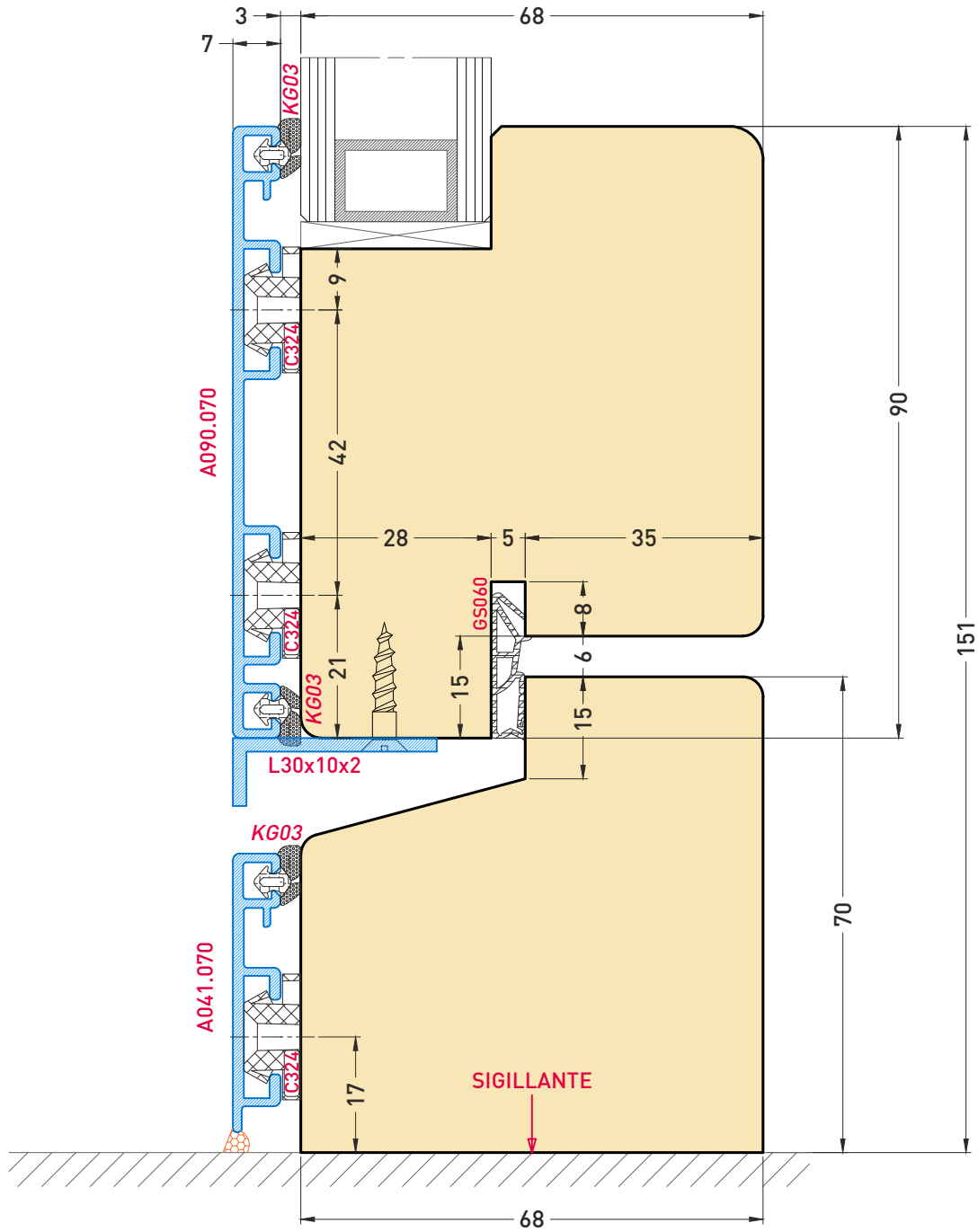

# Annotazioni varie

A series of horizontal dashed lines for taking notes.

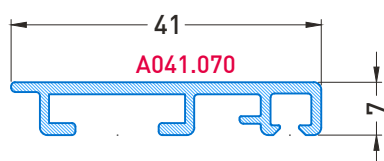
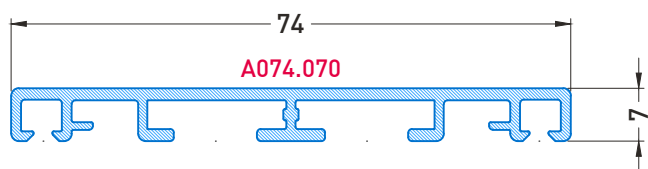
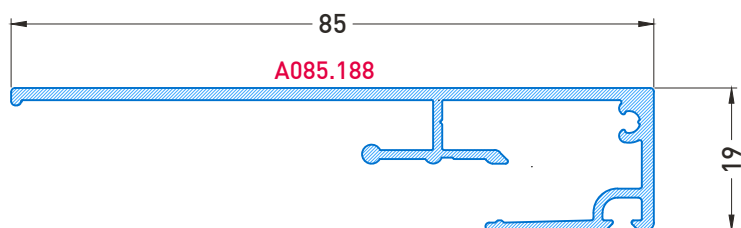
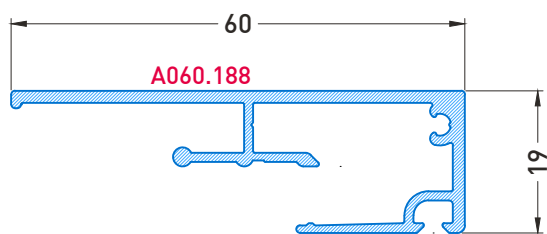
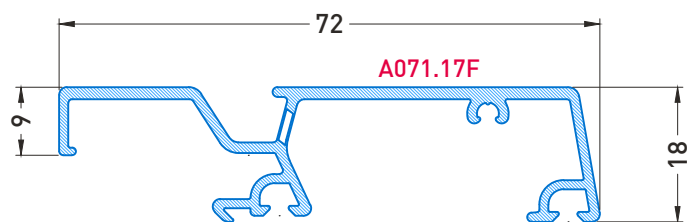
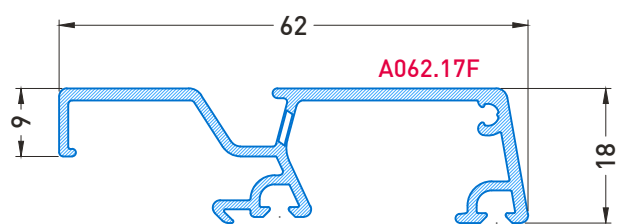

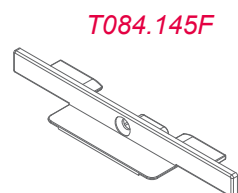
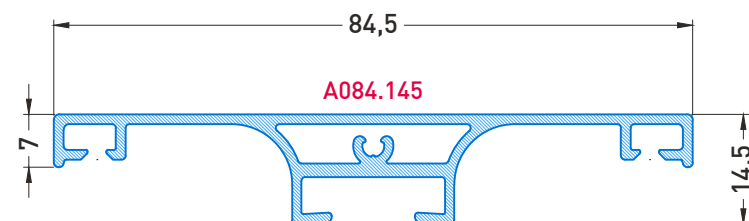
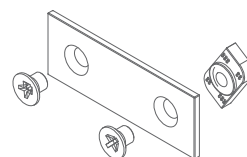
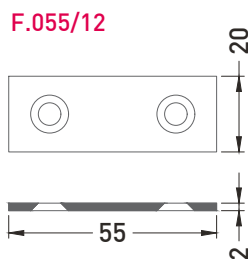
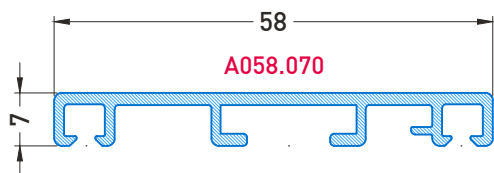
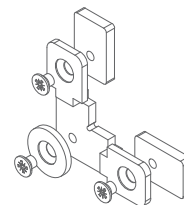
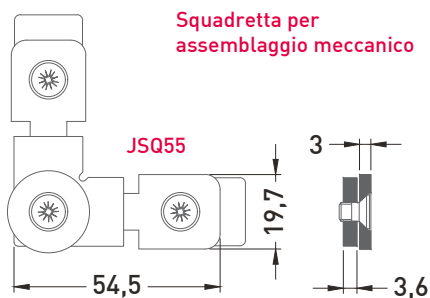
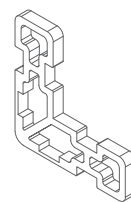
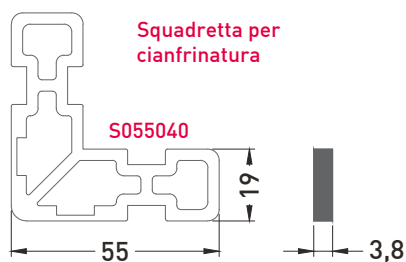
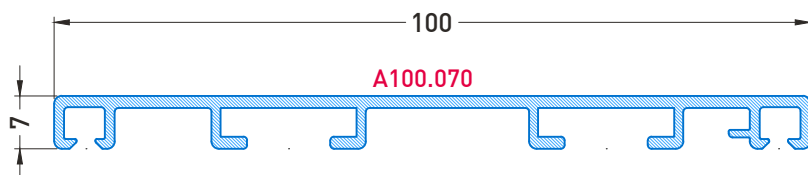
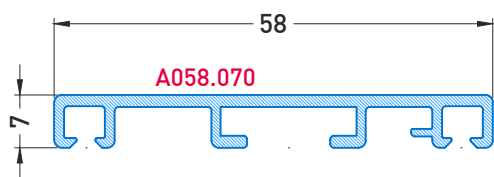
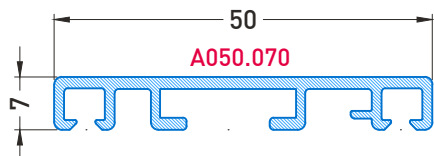
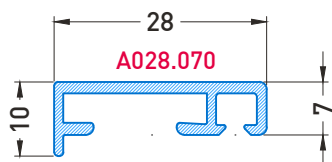

**T084.145P**

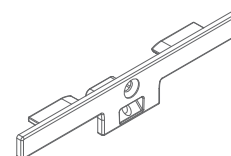

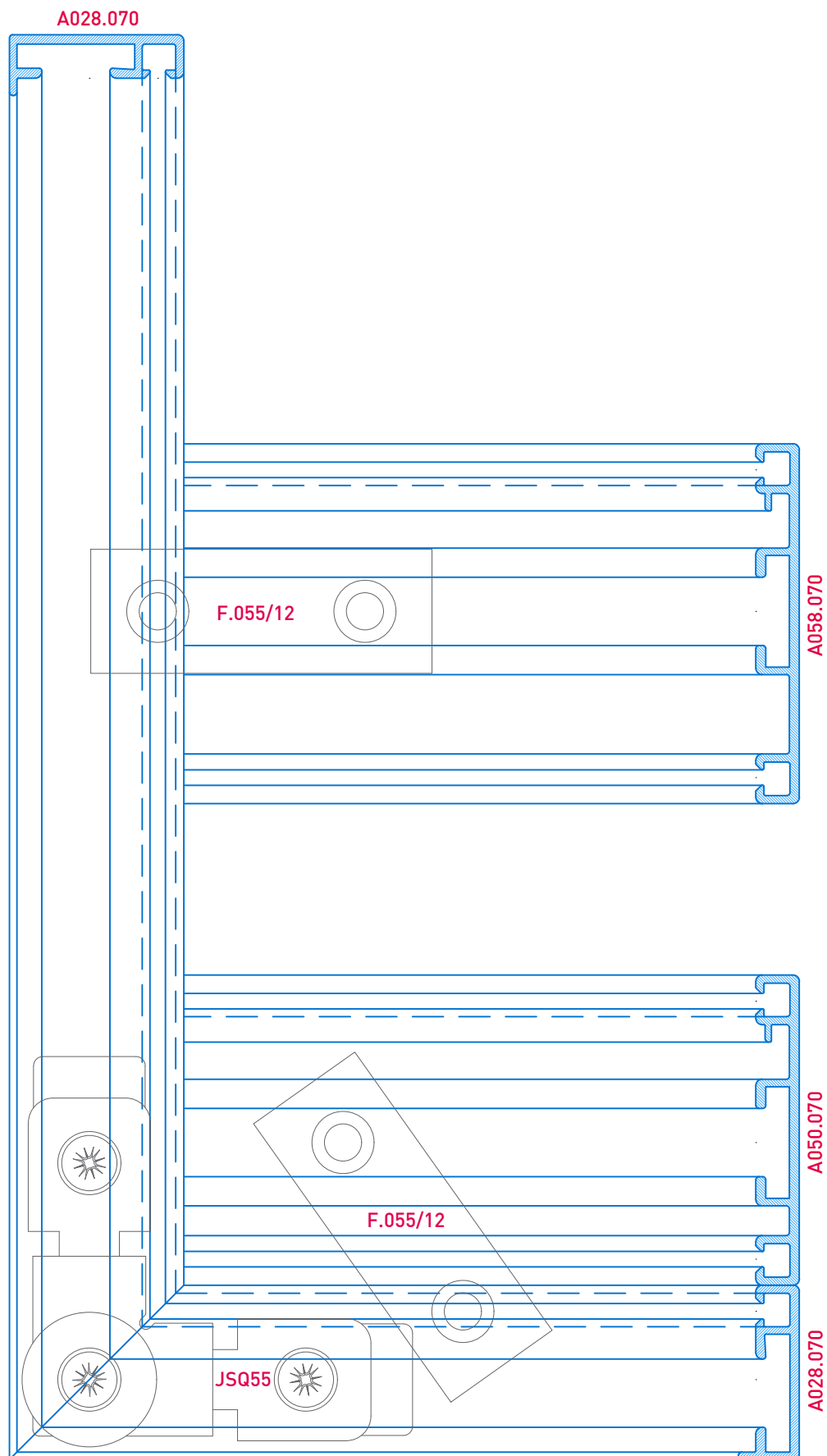

LETL= Larghezza esterno telaio legno  
LITA= Larghezza interno telaio alluminio (traversi)  
LIBA= Larghezza interno battente alluminio (traversi)  
HETL= Altezza esterno telaio legno  
HETA= Altezza esterno telaio alluminio (montanti)  
HIBA= Altezza interno battente alluminio (montanti)

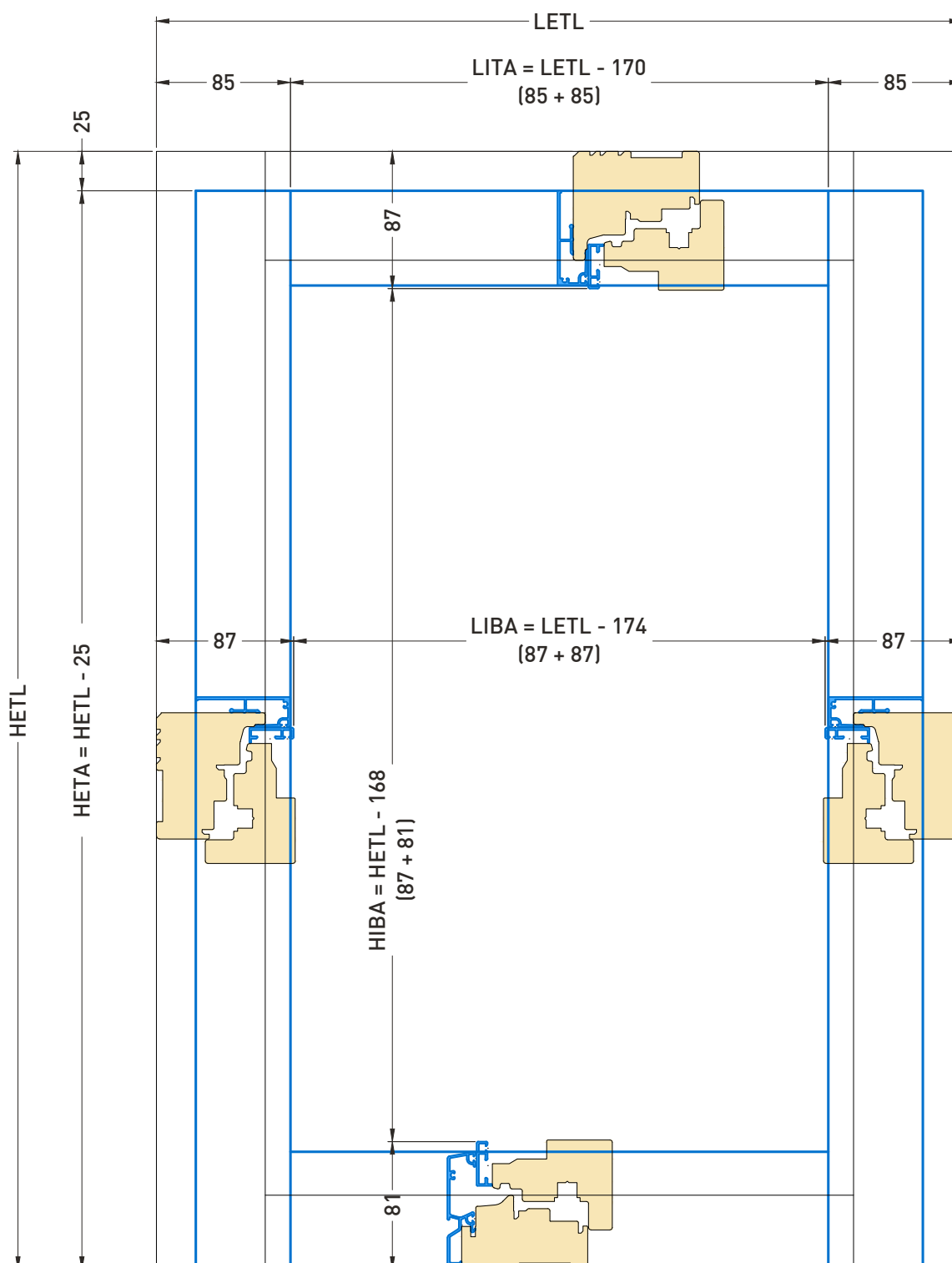

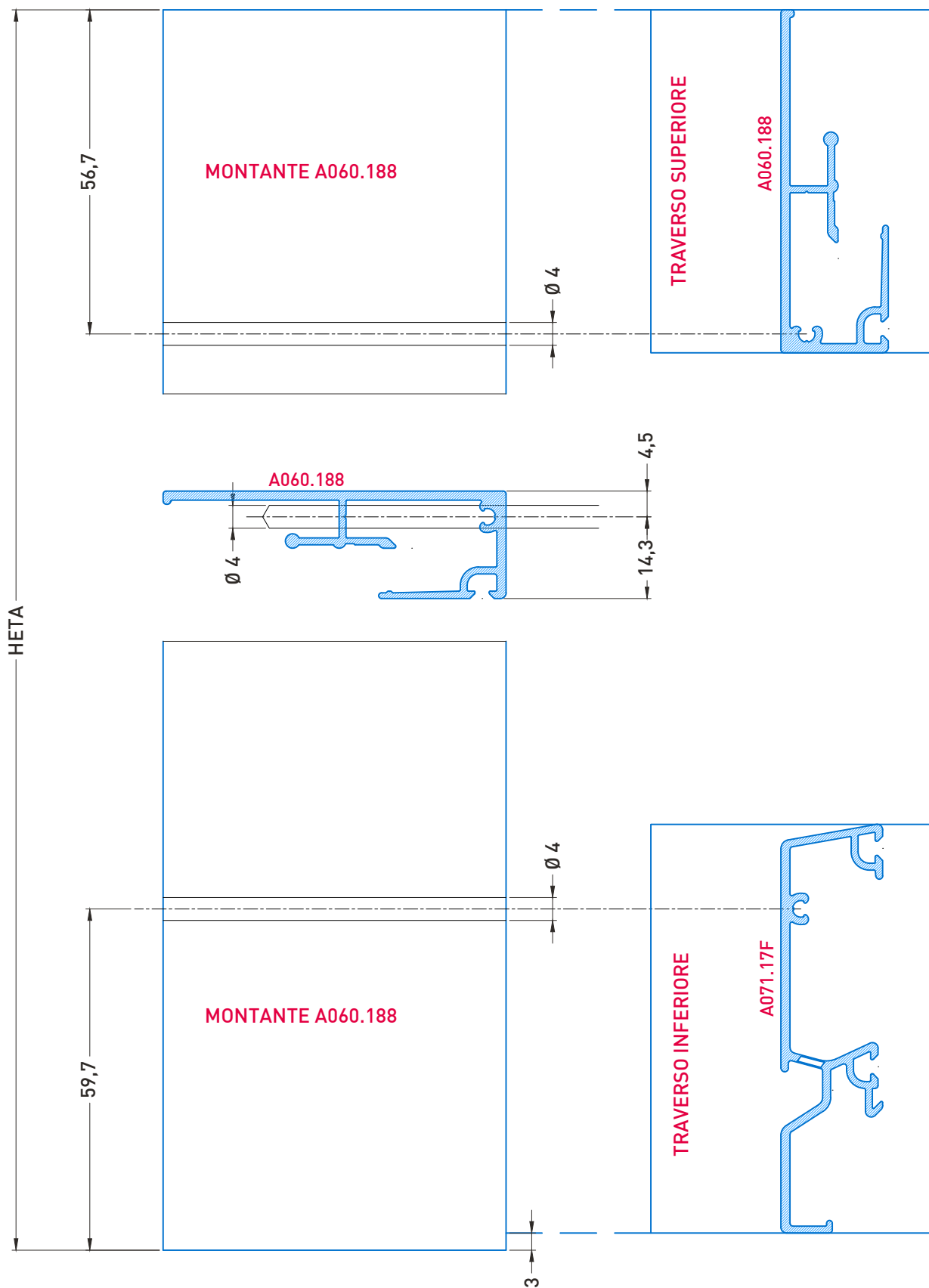



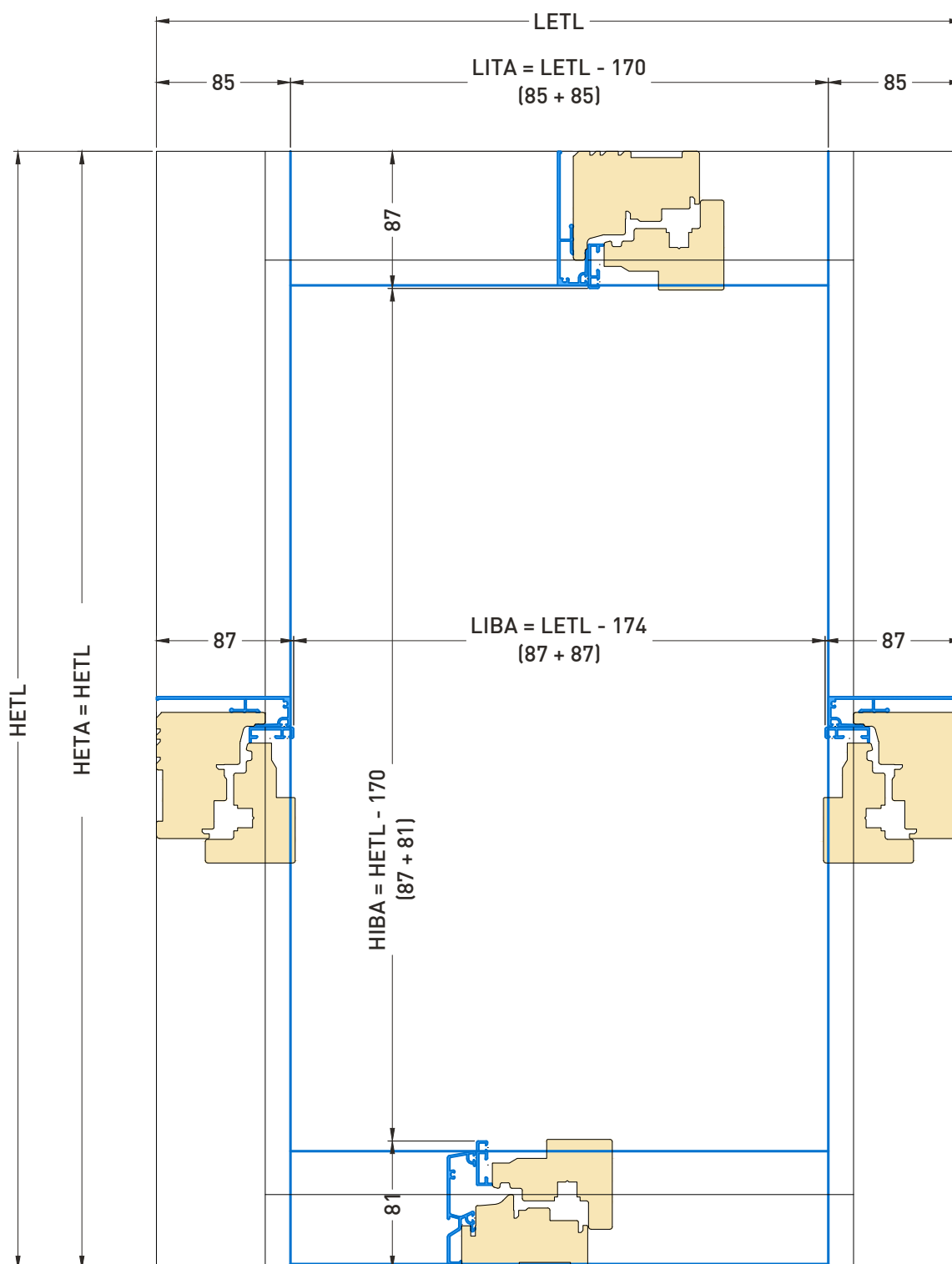

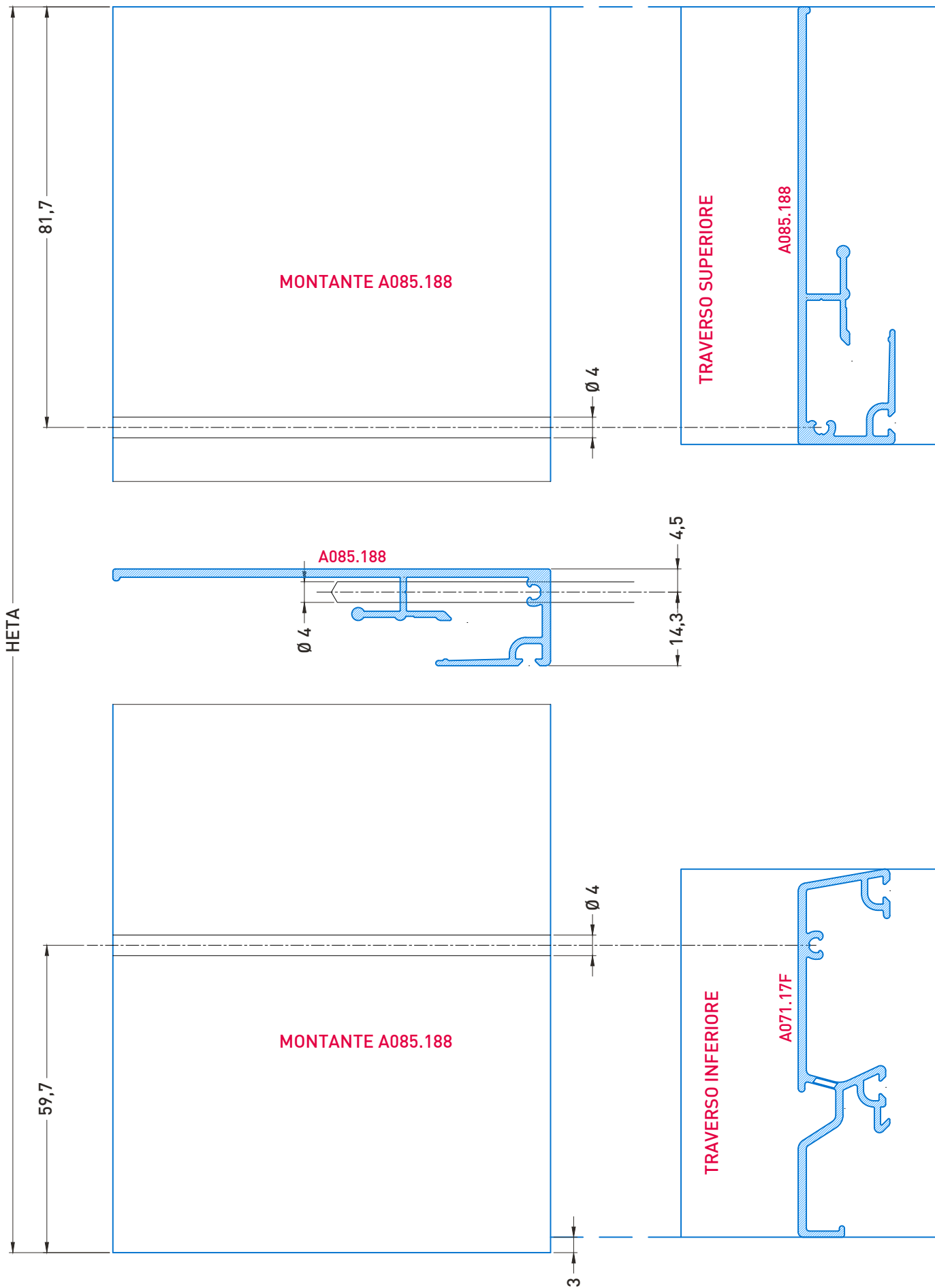

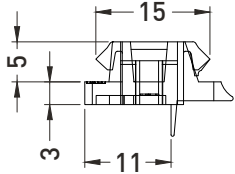
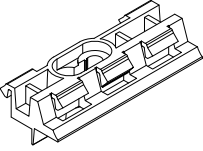
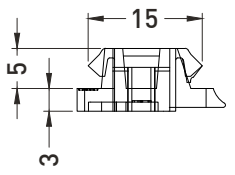
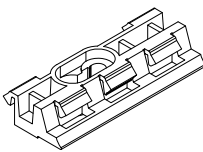
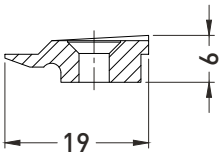
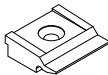
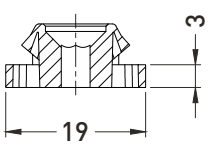
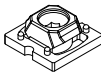



LETL= Larghezza esterno telaio legno  
LITA= Larghezza interno telaio alluminio (traversi)  
LIBA= Larghezza interno battente alluminio (traversi)  
HETL= Altezza esterno telaio legno  
HETA= Altezza esterno telaio alluminio (montanti)  
HIBA= Altezza interno battente alluminio (montanti)

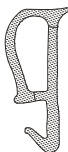



ET423	Clips		
KM400N			Clip a scatto
KM401N			Clip a scatto
C.620			Clip a scatto
C.324			Clip a scatto

ET423	Guarnizioni	
GT.30		EPDM + espanso
KG03		TPE + espanso
GS184		EPDM
GS050		EPDM
GR085		TPE
GR095		TPE
GS060		EPDM
GU210		TPE
GU225		EPDM
GR245		TPE



3-Montare i profili in alluminio del telaio sul legno secondo in ordine le fasi illustrate e descritte qui di seguito:

3a-Incastrare i montanti;

3b-Incastrare il traverso superiore;

3c-Inserire guarnizione (GT30) nel traverso inferiore;

3d-Incastrare il traverso inferiore;

3e-Bloccare il telaio in alluminio avvitando le viti precedentemente già inserite (2a);

3f-Inserire guarnizione (GT30) nel telaio;

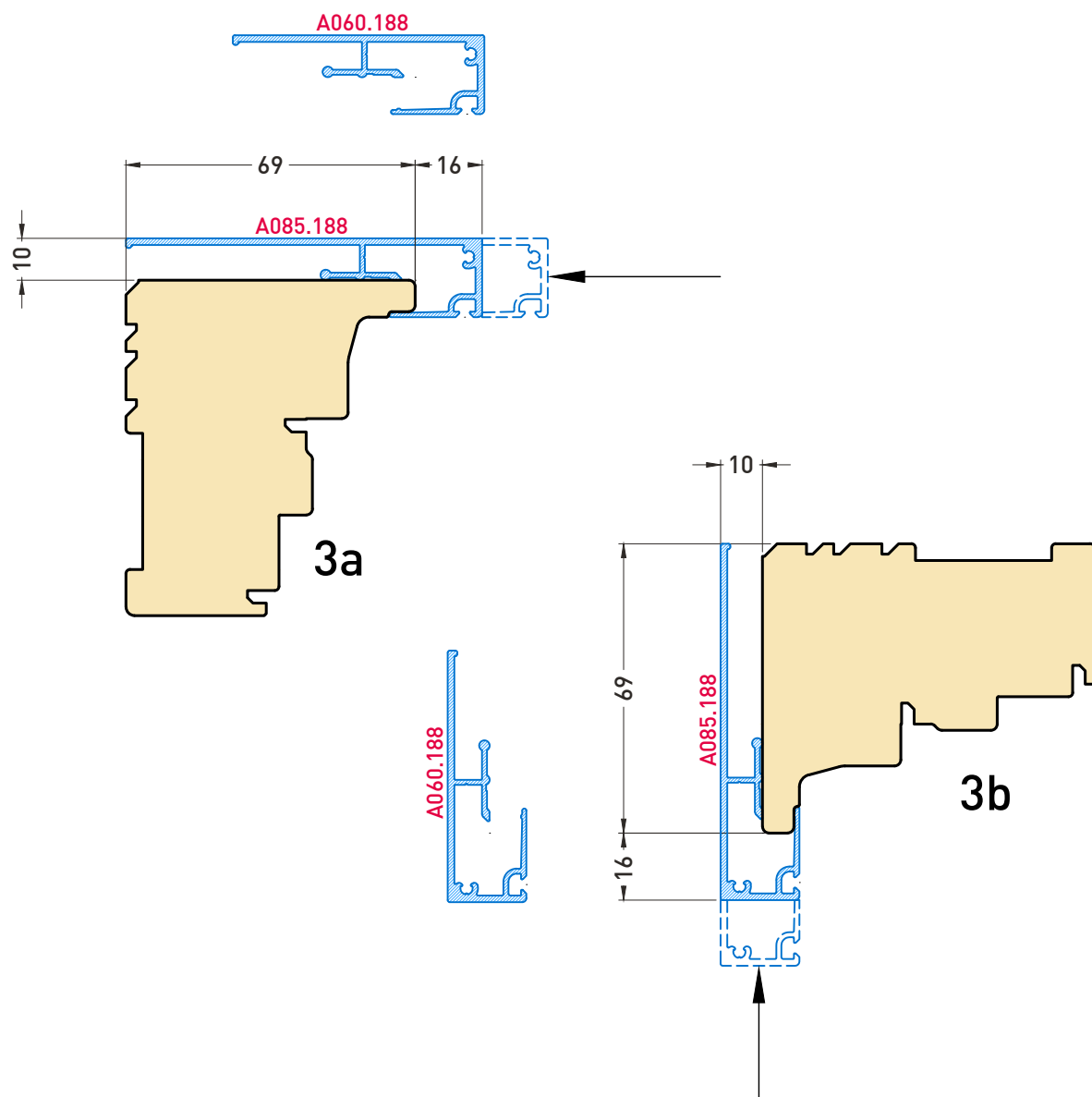

3c

A071.17F

GT30

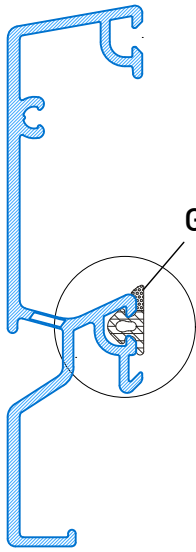

A071.17F

GT30

3d

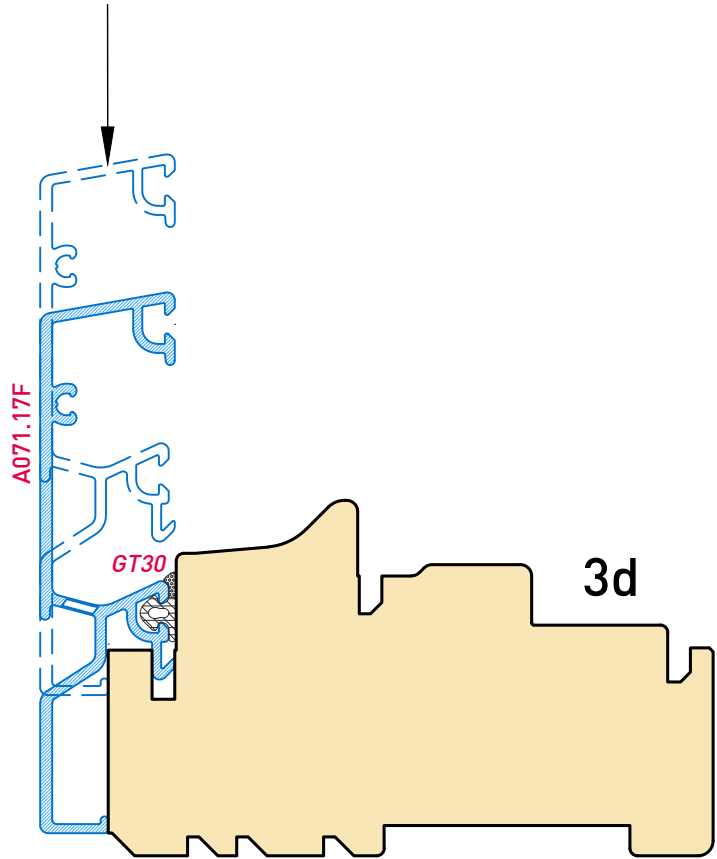

3e

GT30

A071.17F

GT30

3f

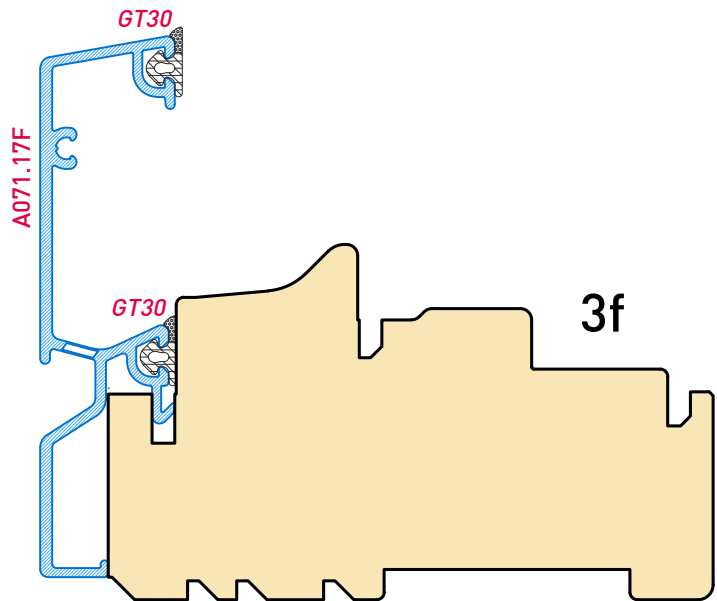
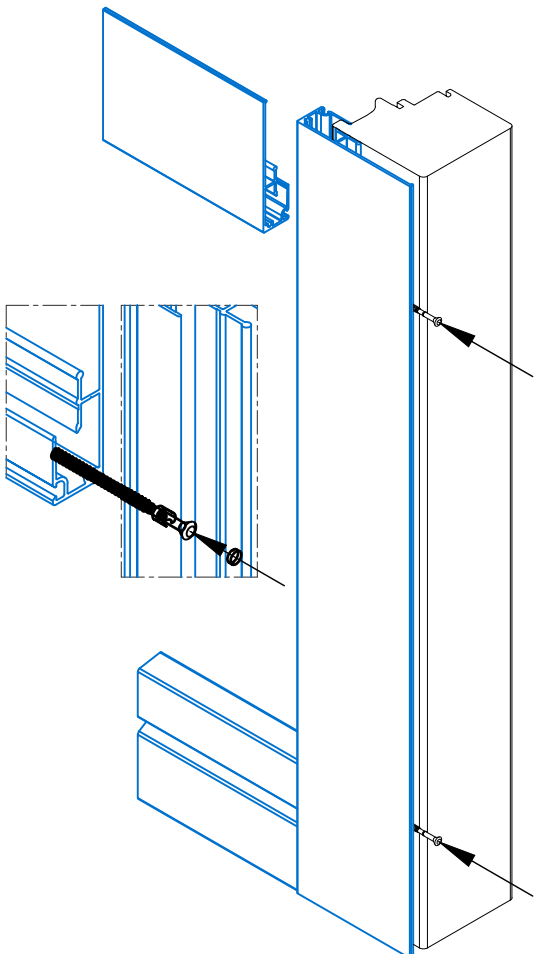

# Annotazioni varie

A series of horizontal dashed lines for taking notes.



# Annotazioni varie

A series of horizontal dashed lines for writing notes.

# Annotazioni varie

A series of horizontal dashed lines for taking notes.

# Annotazioni varie

A series of horizontal dashed lines for taking notes.



**EUROPROFILI GROUP S.p.a.**  
**Via Padana Superiore n. 178**  
**25035 Ospitaletto (BS)**  
**Tel 030.27.22.393 - Fax 030.21.40.202**  
**P.IVA e C.F. 01075920171 - REA BS 230419**  
**Cap. Soc. € 4.500.000,00**  
**[www.europrofiligroup.it](http://www.europrofiligroup.it)**